

Professional Data Input Systems Made in Germany

InduKey[®]
Industrial Input Devices



IP
65



About Us Company

www.company.indukey.com



InduKey® is one of the global leaders in the development and manufacture of data input systems. As a technology-oriented company we offer the complete range of professional operation components and devices. We provide standard products as well as customized solutions particularly for sectors such as engine building, tool building, automation, traffic and medical engineering.

Our services range from development, comprehensive design and production processes to the complete production maturity of product lines. Due to the high degree of vertical integration InduKey® is able to manufacture small and medium quantities of high-quality and specifically designed data input systems. This also applies to OEM production. In this field we are a competent and responsible partner for long-term projects.

Our work focuses on the compliance with high quality standards meeting the complex requirements of our customers. A consistent quality assurance concept ranging from procurement to satisfied customers forms the basis for this.

Due to technical know-how, experience from challenging projects and excellently qualified employees InduKey® has become a dynamic and innovative company. Therefore, one of our core competencies is being able to offer an adequate solution for the respective task.

Since its foundation in 1996 InduKey® manufactures its products in the German facility. The company is certified according to ISO 9001:2008. Due to a global distribution network our products are available all over the world.

The following sectors benefit from our know-how:

- Engine building
- Automation
- Vehicle manufacturing
- Tool building
- Medical engineering
- Chemical industry
- Food industry
- Electrical engineering
- Industrial control systems
- POS/ POI

On the www.indukey.com website you can find a technology-specific and detailed product presentation, technical information as well as product and company news.

One of the highlights of the present catalogue is its Internet-linkage. Each topic is provided with a link located in the top line of each page. This link allows for a fast access to up-to-date contents.

In addition to downloading the current catalogue further information brochures and data sheets are available online as well.



fotolia.com/kounadeas



Catalogue InduKey



Head office, Treuen, Germany



Data input technology Made-in-Germany



Flexible production structures

Maahantuojia : Scanmagnetics Oy - Puh. 09-271 2200

Content	Page
Keyboards	
Foil covered industrial keyboards	6
Flat input keyboards	18
Intrinsically safe industrial keyboards	24
Keyboards and mice for cleaning and disinfection	28
Stainless steel/ Carbon keyboards	32
Keyboards with silicone keys	36
Pointing devices	40
Decoders and accessories	44
Customized solutions	48
Technical information	60
Services	62
Contact & Support	63



www.indukey.com

web : www.scanmagnetics.com

email : indukey [at] scanmagnetics.com



Definition and Meaning



The products in this catalogue are accompanied by one or more symbols. These visualizations provide information about the different features and additional functions. Meaning of the individual symbols:



IP-rating: Provides information about dust protection and protection against ingress of water



Underwaterproof: Is an in-company test standard by InduKey (see p. 60) which exceeds the highest protection level with regard to keyboards: IP68.



Edge protection: A deeper recess in the mounting plate enhances the protection of the foil against mechanical delamination on the edges.



Antimicrobial properties: The surface material contains silver ions which prevent bacteria and germs from growing



Lighting function: Backlight of the operating panel in order to make keys and their marking visible in poor visibility conditions.



EX-accredited: Devices which can securely be used in explosion-prone areas. Those devices conform to the so called EX-standard.



Wireless: RF-based wireless data transfer



Integrated Cursor control: Trackball, touchpad, mouse button, joystick



Mounting type: Housing optionally with VESA boreholes, front mounting, rack mounting



Interfaces: Respective available standard configuration



Modifications: Individual customisation of standard devices possible

TKS-088b-TOUCH-AM-KGEH

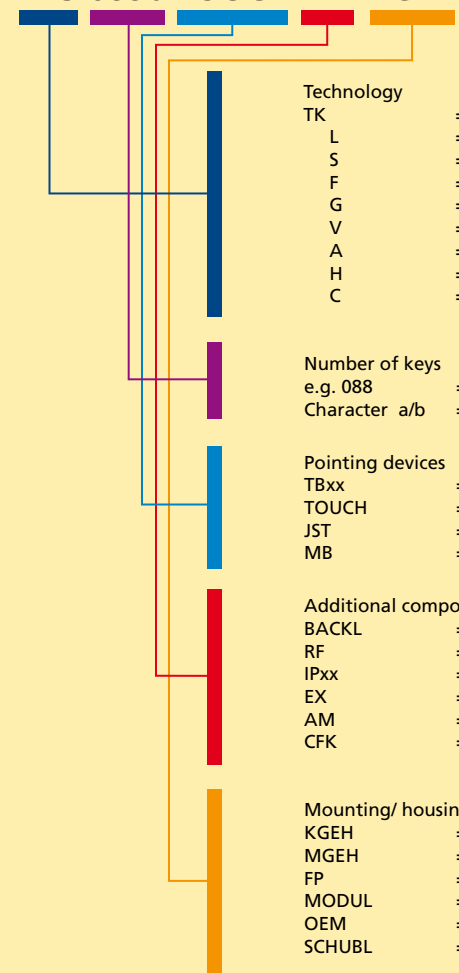

Technology

- TK = Internal information
- L = Long travel keyboards
- S = Short travel keyboards
- F = Flat input keyboards
- G = Keyboards with silicone keys
- V = Vandal proof keyboards
- A = Accessories
- H = Pointing devices
- C = Controller

Number of keys

- e.g. 088 = 88 Keys
- Character a/b = a = Original type, b = Change index

Pointing devices

- TBxx = Trackball with diameter indication
- TOUCH = Touchpad
- JST = Joystick
- MB = Mouse button

Additional component/ feature

- BACKL = Backlight function
- RF = Radio transmission
- IPxx = IP rating
- EX = Approved explosion protection
- AM = Antimicrobial properties
- CFK = Carbon front panel

Mounting/ housing type

- KGEH = Plastic housing
- MGEH = Metal housing
- FP = 19-inch front panel with mounting holes
- MODUL = Front panel with threaded studs
- OEM = Keypad without frame
- SCHUBL = 19-inch drawer



Make more of a keyboard!



Even more individual, even more application-oriented:
 Besides the standard models offered in the following which are always available, the foil covered keyboards of the TKS-series offer an enormous width of possible modifications. Talk to our project engineers about the various options.



Legend:

- 1 Integrated trackball, possible in different designs, e. g. optical or analogue, as 38-mm or 50-mm version
- 2 Integrated touchpad
- 3 Joystick
- 4 Antimicrobial surface prevent bacteria and germs from growing
- 5 InduPrint technology: Possibility of individual foil printing
- 6 InduSense technology: Relief printing on operating panels
- 7 Integrated chip card reader
- 8 Additional buttons and keys
- 9 InduClean technology: Nano paint coating with Lotos effect



TKS Series

The TKS series is the most requested industrial keyboard line. The devices of this series feature ruggedness and a variety of mounting options and models. They are water and dust proof and can be cleaned. These keyboards are equipped with cursor controls and they offer a pleasant tactile feel while having robust switching elements.

This keyboard series was especially developed for being used in rugged environments. Having a robust metal front panel and a closed foil surface, these devices are suited for

the application in difficult environmental conditions. This is important for industrial systems requiring operational reliability of the data input module over a long period of time.



Foil Covered Industrial Keyboards



Mounting/ housing type:



Plastic housing

Page 9



Front mounting

Page 11



Rack mounting
Drawer (Rack, 1 RU)

Page 17
Page 15

Further characteristics:



Antimicrobial surface

Page 9



Explosion protection

Page 27



Edge protection

Page 13

The models of the TKS series are particularly used in the following application areas and industries:

- Engine building
- Automation
- Vehicle manufacturing
- Tool building
- Medical engineering
- Chemical industry
- Food industry
- Electrical engineering
- Industrial control systems
- Military
- Construction of instruments
- Control and observation stations

TKS Series – Plastic Housing



Figure: radio decoder included in delivery



TKS-105a-KGEH

This keyboard is the base model of the successful TKS type series. It is based on high-quality electromechanic short travel keys and provides an excellent, tactile feedback and a long service life. The closed surface is resistant to water, dust, and other substances which are to be found in the industry. As housing version, it comes with the usual MFII layout of a customary PC keyboard.

TKS-105a-TB38-KGEH and TKS-105a-TOUCH-KGEH are the two variants with integrated trackball or touchpad as mouse pointing device.



Wireless keyboard: TKS-105a-TB38-RF-KGEH

Foil covered short travel keyboard in rugged plastic housing with trackball and integrated radio-based decoder.

- Multi-channel capable (more than 100 systems synchronously usable in transmission range)
- Long battery life by means of automatic standby-switching mechanism
- Only to be used with the described battery type and the enclosed battery charger



INDUMEDICAL™

Antimicrobial: TKS-088-TOUCH-AM-KGEH

The keyboard, also known as **InduMedical™** is equipped with an antimicrobial surface. Thus, the growth and spread of micro-organisms is prevented. It is especially suitable for the application in hospitals, medical practices as well as other applicational areas which are sensitive to hygiene.

For example realizable on request:

- Other country layouts (standard: DE and US)
- Customized change of colour
- Integration of your company logo
- VESA-compatible mounting points

TKS Series – Plastic Housing

Technical data: KGEH-versions

Switching technology: short travel keys
 Switching force: 2.6 N
 Switch travel: 0.3 mm
 Switching cycles: approx. 1 Mio. (per key)
 Housing design: plastic housing (KGEH)
 Housing material: ABS
 Interfaces: PS/2; USB
 Operating temp.: -25 °C to +70 °C ¹
 Storage temp.: -25 °C to +80 °C ³
 Layout (standard): QWERTY (US); QWERTZ (DE)

Side views ²:

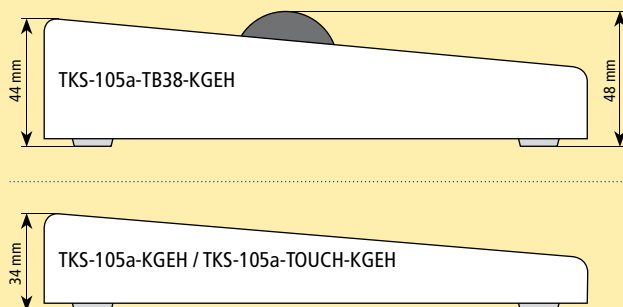

Here you will find further housing and mounting versions of the TKS Series:

- Front mounting Page 11
- Rack mounting Page 17
- Drawer Page 15
- Explosion protection Page 27
- With edge protection Page 13

- Further pointing devices:
- 50-mm trackball version Page 11
- Joystick version Page 11

i **Technical data of the integrated touchpad**

Operating principle: capacitive
 Resolution: 100-300 dpi
 Dimensions: 65 x 49 mm
 Active surface: 59 x 42 mm

On page 42 you will find further detailed information on the various pointing devices.

Product description	Number of keys	Pointing device	Protection level		Dimensions (mm)	Housing
			static	dynamic		
TKS-105a-KGEH	105	-	IP65		480 x 182 x 34	Plastic housing
TKS-105a-TB38-KGEH	105	Trackball, 38 mm	IP65	IP54	480 x 182 x 44 (48)	Plastic housing
TKS-105a-TOUCH-KGEH	105	Touchpad	IP65		480 x 182 x 34	Plastic housing
TKS-105a-TB38-RF-KGEH	105	Trackball, 38 mm	IP65	IP54	480 x 182 x 44 (48)	Plastic housing
TKS-104a-KGEH	104	-	IP65		372 x 182 x 34	Plastic housing
TKS-088a-TB38-KGEH	88	Trackball, 38 mm	IP65	IP54	372 x 182 x 44 (48)	Plastic housing
TKS-088a-TOUCH-KGEH	88	Touchpad	IP65		372 x 182 x 34	Plastic housing
TKS-088-TOUCH-AM-KGEH	88	Touchpad	IP65		372 x 182 x 34	Plastic housing
TKS-030-KGEH	30	-	IP65		125 x 150 x 31	Plastic housing
TKS-030-TOUCH-KGEH	30	Touchpad	IP65		125 x 195 x 31	Plastic housing

Other layouts, configurations and interfaces on request

¹ Keyboards with pointing device: 0 °C to +70 °C ² Sketched representation ³ Wireless version: -10 °C to +50 °C

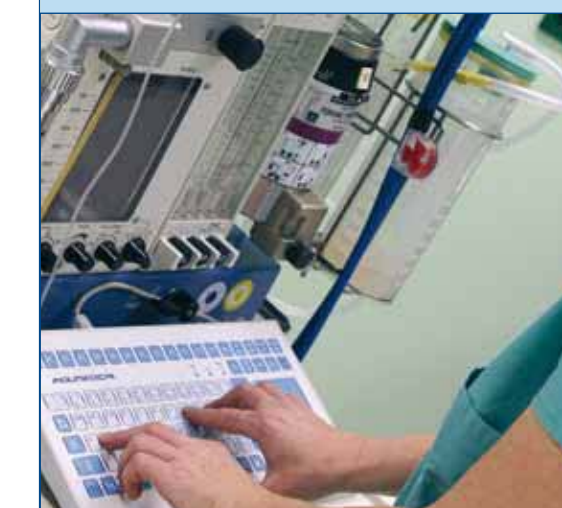

In addition to the antimicrobial protection the keyboard can also be disinfected and wiped. The InduMedical™ is sealed to IP65 standard making it impervious to dust and liquids and comes with a rugged ABS case.

TKS Series – Front Mounting



Optical 50-mm Trackball: TKS-105a-TB50oF80-MODUL



Integrated joystick: TKS-105a-JSTb-MODUL



Front mounting

The front mounting of a keyboard is the kind of systems integration which is most widely used in the field of engine and tool building. The input device is firmly linked to the system; if it is accordingly mounted, a plane surface of the operating panel is the result.

The front mounting is performed by means of threaded fastening bolts which are installed on the rear side of the keyboard front panel. The keyboard is embedded into the mounting surface of the system and is then screwed in place. A gasket reliably prevents liquids and dust from entering the carrier system. In order to create the cut-out, a cutting template can be used. For the mounting of the keyboard, the stay bolts are screwed by means of screw nuts. In order to protect the

circuit board of the keyboard, the back of the keyboard is equipped with a metal protective tray.

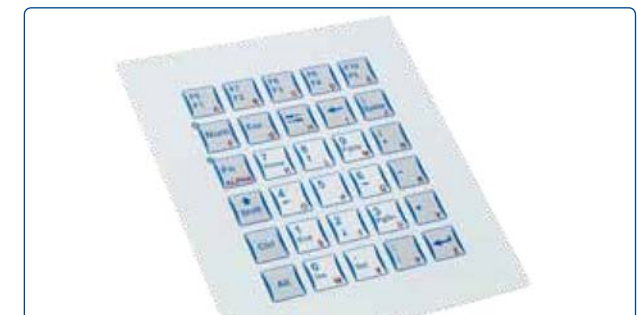
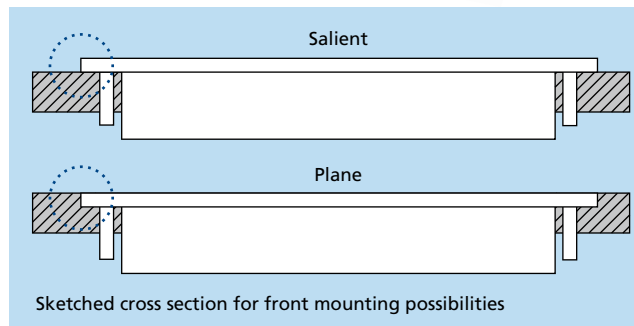

Compact: TKS-030-MODUL

TKS Series – Front Mounting

Technical data: MODUL-versions

Switching technology: short travel keys
 Switching force: 2.6 N
 Switch travel: 0.3 mm
 Switching cycles: approx. 1 Mio. (per key)
 Housing design: front panel with threaded bolts
 Front panel material: aluminium
 Interfaces: PS/2; USB
 Operating temp.: -25 °C to +70 °C¹
 Storage temp.: -25 °C to +80 °C
 Layout (standard): QWERTY (US); QWERTZ (DE)

Side views²:

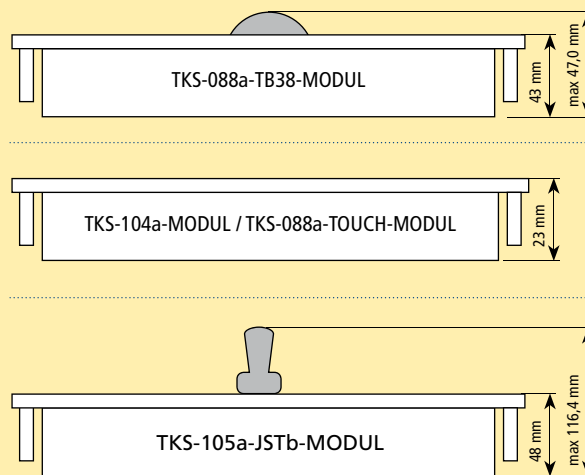

i **Technical data of the integrated touchpad**

Operating principle: capacitive
 Resolution: 100-300 dpi
 Dimensions: 65 x 49 mm
 Active surface: 59 x 42 mm

Product description	Number of keys	Pointing device	Protection level		Dimensions (mm)	Mounting
			static	dynamic		
TKS-105a-MODUL	105	-		IP65	482,6 x 177,8 x 23	Front
TKS-105a-TB38-MODUL	105	Trackball, 38 mm	IP65	IP54	482,6 x 177,8 x 48 (58)	Front
TKS-105a-TB50oF80-MODUL ³	105	Trackball, 50 mm	IP65	IP65	482,6 x 177,8 x 48 (58)	Front
TKS-105a-TOUCH-MODUL	105	Touchpad		IP65	482,6 x 177,8 x 23	Front
TKS-105a-JSTb-MODUL	105	Joystick		IP65	482,6 x 177,8 x 48 (116,4)	Front
TKS-104a-MODUL	104	-		IP65	370 x 180 x 23	Front
TKS-088a-TB38-MODUL	88	Trackball, 38 mm	IP65	IP54	370 x 180 x 43 (47)	Front
TKS-088a-TOUCH-MODUL	88	Touchpad		IP65	370 x 180 x 23	Front
TKS-030-MODUL	30	-		IP65	141 x 157 x 15,4	Front
TKS-030-TOUCH-MODUL	30	Touchpad		IP65	141 x 196 x 15,4	Front

Other layouts, configurations and interfaces on request

¹ Keyboards with pointing device: 0 °C to +70 °C ² Sketched representation ³ Optical trackball



Here you will find further housing and mounting versions of the TKS Series:

- Housing Page 9
- Rack mounting Page 17
- Drawer Page 15
- Explosion protection Page 27
- With edge protection Page 13



Stay bolts which are installed on the rear side of the keyboard front panel allow for a mounting of the keyboard to the respective mounting surface. A cutting template can help to create the mounting cut-out.

TKS Series with Edge Protection



Front mounting with edge protection

In contrast to the conventional front mount models (see p. 10), those front mounting variants have a heightened revolving edge. The edge protection is realized by a deeper milling of the front panel.

The reason for this variation is an increased protection of the front foil. Especially with regard to keyboards which are not plane mounted, it may be possible that the foil comes off on the edges and borders. Particularly with regard to machines and plants in mechanically demanding areas, the edge protection ensures a long durability of the device.

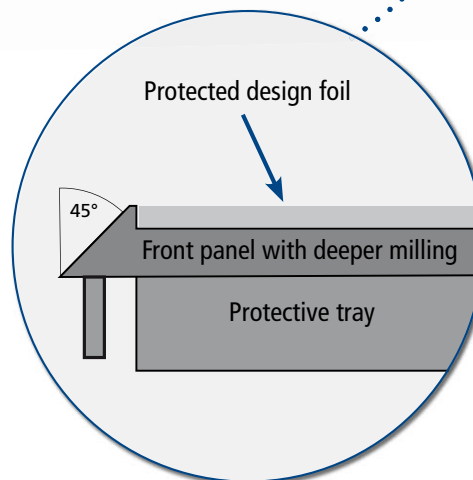

TKS-105b-TB38-MODUL



TKS-105b-TB50oF80-MODUL



TKS-105b-TOUCH-MODUL

TKS Series with Edge Protection

Technical data: MODUL-versions with edge protection

Switching technology: short travel keys
 Switching force: 2.6 N
 Switch travel: 0.3 mm
 Switching cycles: approx. 1 Mio. (per key)
 Housing design: front panel with threaded bolts
 Front panel material: aluminium
 Interfaces: PS/2; USB
 Operating temp.: -25 °C to +70 °C¹
 Storage temp.: -25 °C to +80 °C
 Layout (standard): QWERTY (US); QWERTZ (DE)

i **Technical data of the integrated touchpad**

Operating principle: capacitive
 Resolution: 100-300 dpi
 Dimensions: 65 x 49 mm
 Active surface: 59 x 42 mm

Product description	Number of keys	Pointing device	Protection level		Dimensions (mm)	Mounting
			static	dynamic		
TKS-105b-MODUL	105	-	IP65		482,6 x 177,8 x 23	Front
TKS-105b-TB38-MODUL	105	Trackball, 38 mm	IP65	IP54	482,6 x 177,8 x 48 (58)	Front
TKS-105b-TB50oF80-MODUL ²	105	Trackball, 50 mm	IP65	IP65	482,6 x 177,8 x 48 (58)	Front
TKS-105b-TOUCH-MODUL	105	Touchpad	IP65		482,6 x 177,8 x 23	Front
TKS-105b-JSTb-MODUL	105	Joystick	IP65		482,6 x 177,8 x 48 (116,4)	Front
TKS-104b-MODUL	104	-	IP65		370 x 180 x 23	Front
TKS-088b-TB38-MODUL	88	Trackball, 38 mm	IP65	IP54	370 x 180 x 43 (47)	Front
TKS-088b-TOUCH-MODUL	88	Touchpad	IP65		370 x 180 x 23	Front
TKS-030b-MODUL	30	-	IP65		141 x 157 x 15,4	Front
TKS-030b-TOUCH-MODUL	30	Touchpad	IP65		141 x 196 x 15,4	Front

Other layouts, configurations and interfaces on request

¹ Keyboards with pointing device: 0 °C to +70 °C ² Optical trackball



Here you will find further housing and mounting versions of the TKS Series:

Housing	Page 9
Front mounting	Page 11
Rack mounting	Page 17
Explosion protection	Page 27
Drawer	Page 15



Front-mounted keyboards with edge protection secures the front foil against delamination due to mechanical influences. This product variant is called „b-variant“ at InduKey; the „a-variant“ represents the conventional front mount model.

TKS Series – Rack Mounting



Rack mounting:

One type of front mounting is the installation into industrial rack systems. In the majority of cases, these systems are subject to the 19" system. In this context, 19" or 482.6 mm refer to the width of the racks which can be stored on rails inside the cabinet; therefore they are extractable and retractable. The height of one cassette compartment is subject to a standardisation as well. Here, rack units play a significant role. Those units, called RU, have a height of 1.75" or 44.45 mm per unit.

With the FP-Series, InduKey has developed a product family of industrial keyboards which are precisely adapted to the specifications of the 19" system. All those keyboards have a width of 19"; according to the rack units, models with 1 (drawer version), 3 or 4 RU are available. The mounting of the industrial keyboards of the InduKey-FP-Series is performed by means of boreholes on the front of the keyboard front panel. The keyboard front panel is connected to the frame of the rack by means of a screw.

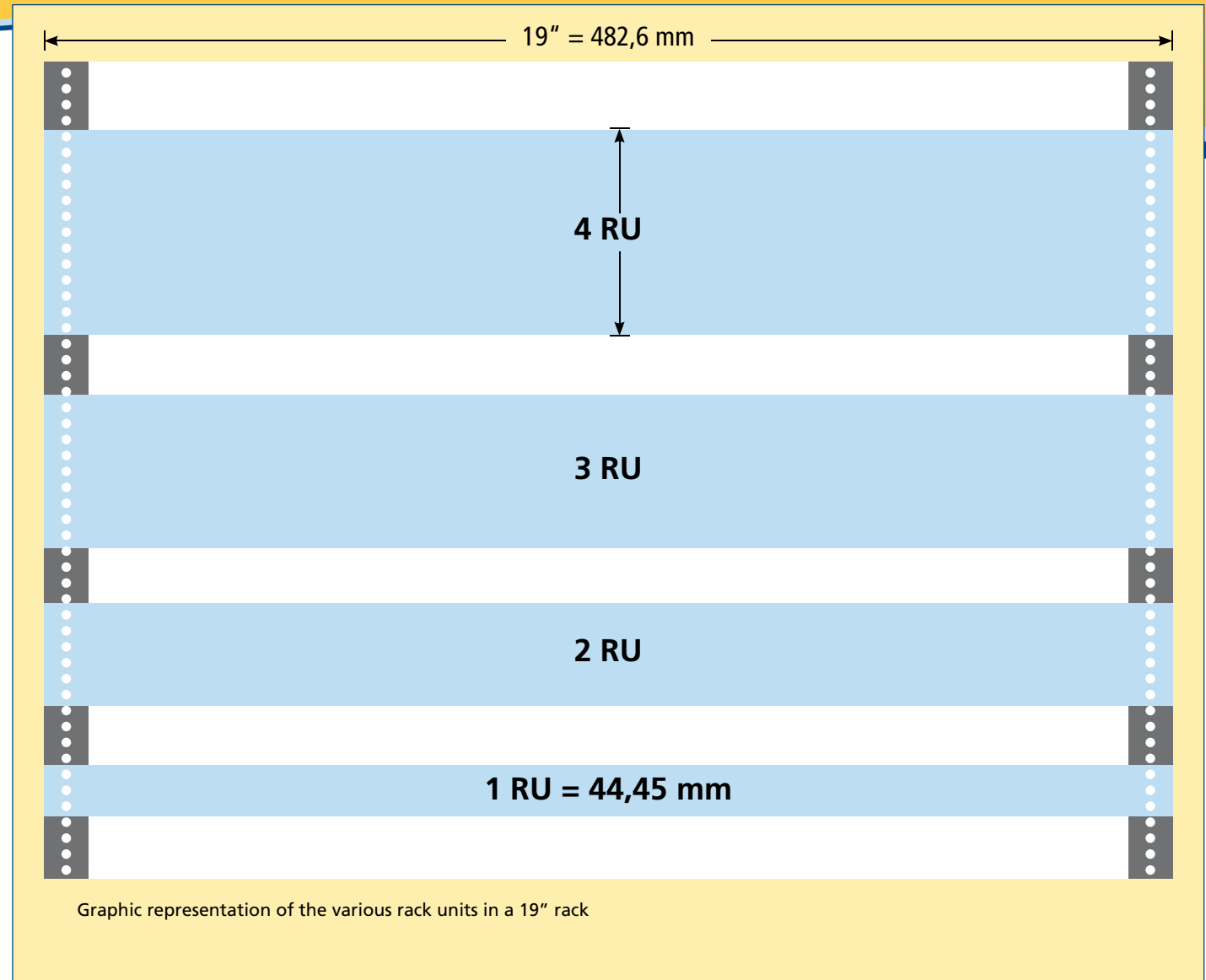



Foil Covered Industrial Keyboards TKS Series – Drawer



Technical data: version with drawer

Switching technology:	short travel keys
Switching force:	2.6 N
Switch travel:	0.3 mm
Switching cycles:	approx. 1 Mio. (per key)
Mounting type:	19" drawer (1 RU)
Front panel material:	aluminium
Interfaces:	PS/2; USB
Operating temp.:	-25 °C to +70 °C ¹
Storage temp.:	-25 °C to +80 °C
Layout (standard):	QWERTY (US); QWERTZ (DE)

Front view ²:

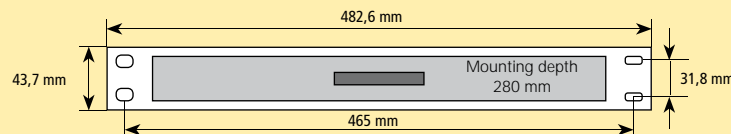

Technical data of the integrated touchpad

Operating principle:	capacitive
Resolution:	100-300 dpi
Dimensions:	65 x 49 mm
Active surface:	59 x 42 mm

The extracted drawers are bendable up to approx. 15°!

Rugged keyboard/ drawer combination

This aesthetically appealing mounting variant of the TKS input system is suited for the use in 19" systems. Due to the low height of 1 RU (1 rack unit = 44.45 mm) it requires very little space. The extracted drawer has an angle of 15° which allows for an easy operation in standing position.

Product description	Number of keys	Pointing device	Protection level		Dimensions (mm)	Mounting
			static	dynamic		
TKS-104a-SCHUBL	104	-		IP65	482,6 x 43,7 x 280	Rack
TKS-088a-TOUCH-SCHUBL	88	Touchpad		IP65	482,6 x 43,7 x 280	Rack

Other layouts, configurations and interfaces on request

¹ Keyboards with pointing device: 0 °C to +70 °C ² Sketched representation

Here you will find further housing and mounting versions of the TKS Series:

Housing	Page 9
Front mounting	Page 11
Rack mounting	Page 17
Explosion protection	Page 27
With edge protection	Page 13



TKS-104a-SCHUBL - Drawer without integrated mouse pointing device



TKS-088a-TOUCH-SCHUBL - Drawer with integrated touchpad (capacitive)

TKS Series – Rack Mounting



Front mounting
3-RU mounting height

TKS-105a-FP-3HE - Those keyboards are ideally suited for the installation into the 19" systems. While 19" refers to the width of the device, one rack unit (RU) means 44.45 mm. This device possesses 3 RU = 133.35 mm.

TKS-105a-TB38-FP-3HE and **TKS-105a-TOUCH-FP-3HE** - These models are the variations with integrated pointing devices. Therefore they are ideally suited for the installation into 19" systems, where the functionality of a mouse is required in addition.



Front mounting
4-RU mounting height

TKS-105a-FP - Being technically identical with the TKS-105a-FP-3HE, this keyboard product family offers all features of a rugged industrial short travel keyboard with a front panel height of 4 RU - perfectly tailored to standardised 19" switch cabinets.

TKS-105a-TB38-FP and **TKS-105a-TOUCH-FP** - These models are the variations with integrated pointing devices.



3-RU: TKS-105a-TB38-FP-3HE with 38-mm-Trackball



4-RU: TKS-105a-TB38-FP with 38-mm-Trackball



Cassette mounting: TKS-030-FP

TKS Series – Rack Mounting

Technical data: front panel versions

Switching technology: short travel keys
 Switching force: 2.6 N
 Switch travel: 0.3 mm
 Switching cycles: approx. 1 Mio. (per key)
 Mounting type: 19" front panel with mounting boreholes
 Front panel material: aluminium
 Interfaces: PS/2; USB
 Operating temp.: -25 °C to +70 °C¹
 Storage temp.: -25 °C to +80 °C
 Layout (standard): QWERTY (US); QWERTZ (DE)

Side views 2:

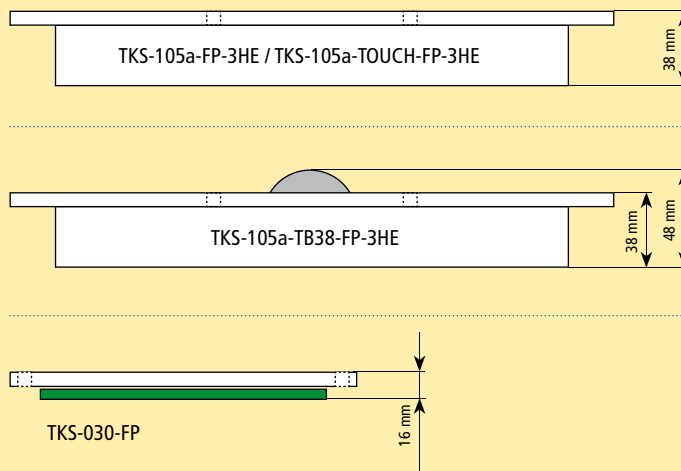

Here you will find further housing and mounting versions of the TKS Series:

Housing	Page 9
Front mounting	Page 11
Drawer	Page 15
Explosion protection	Page 27
With edge protection	Page 13

i **Technical data of the integrated touchpad**

Operating principle: capacitive
 Resolution: 100-300 dpi
 Dimensions: 65 x 49 mm
 Active surface: 59 x 42 mm

Product description	Number of keys	Pointing device	Protection level		Dimensions (mm)	Mounting
			static	dynamic		
TKS-105a-FP-3HE	105	-	IP65		482,6 x 132,5 x 38; 3 RU	Rack
TKS-105a-TB38-FP-3HE	105	Trackball, 38 mm	IP65	IP54	482,6 x 132,5 x 48; 3 RU	Rack
TKS-105a-TOUCH-FP-3HE	105	Touchpad	IP65		482,6 x 132,5 x 38; 3 RU	Rack

Product description	Number of keys	Pointing device	Protection level		Dimensions (mm)	Mounting
			static	dynamic		
TKS-105a-FP	105	-	IP65		482,6 x 177,8 x 23; 4 RU	Rack
TKS-105a-TB38-FP	105	Trackball, 38 mm	IP65	IP54	482,6 x 177,8 x 58; 4 RU	Rack
TKS-105a-TB50of80-FP ³	105	Trackball, 50 mm	IP65	IP65	482,6 x 177,8 x 58; 4 RU	Rack
TKS-105a-TOUCH-FP	105	Touchpad	IP65		482,6 x 177,8 x 23; 4 RU	Rack
TKS-030-FP	30	-	IP65		128,6 x 111,6 x 16; 22 HP, 3 RU	Cassette

Other layouts, configurations and interfaces on request

¹ Keyboards with pointing device: 0 °C to +70 °C ² Sketched representation ³ Optical trackball



In the technical sector, „rack“ designates a frame for electrical devices which has a standardised width of 19“. Therefore, the InduKey keyboards have a front panel width of precisely 482.6 mm in order to meet the requirements of this standardisation. In case of devices of smaller dimensions, such as the TKS-030-FP, a so called cassette mounting is performed in order to appropriately incorporate the device.



TKF Series

The models of the TKF series are suited for the application in rugged environments. The difference to other foil covered industrial keyboards lies in the very flat mounting depth of the TKF keyboards which is achieved by the application of metal domes of a low construction height, which are used as mechanical switch elements. Thus, the keyboards of this category are ideally suited for the installation into devices of a low mounting depth and

compact dimensions. Moreover, a good tactile feedback results from the key drop/switch travel of 0.55 mm. Particularly during the keyboard operation with gloves, the key feedback is well perceptible.

As pointing devices which are integrated into the keyboard, touchpads and trackballs are used.



Flat Input Keyboards



Mounting/ housing type:



Housing

Page 21



Front mounting

Page 23



Rack mounting

Page 23

With adhesive foil on rear side Page 21

The models of the TKF series are particularly used in the following application areas:

- Fittings of all kinds
- Medical equipment engineering
- Measuring and control technology
- Flat control desks
- Industrial PCs
- Control and observation stations
- Information terminals



TKF Series – Housing



Due to its compact dimensions, the keyboard **TKF-085a-KGEH** in an ABS plastic housing is particularly space-saving.

TKF-085a-TB38-KGEH and **TKF-085a-TOUCH-KGEH** are the two variants with an integrated trackball or touchpad as pointing device.

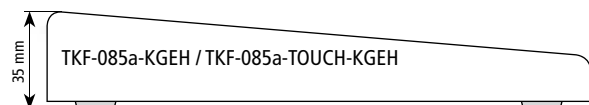
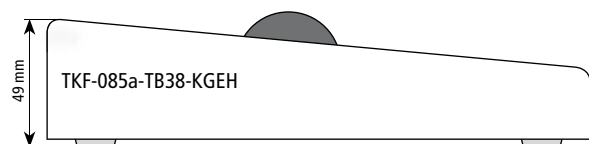

Maahantuojaja : Scanmagnetics Oy - Puh. 09-271 2200



InduStyle™ - TKF-085c-MGEH - With a height of approx. 15 mm, the visually attractive keyboard InduStyle™ is an extremely flat desktop keyboard. In a housing which is completely made of aluminium, the keyboard combines long-lasting quality and functional reliability in rugged environments. As a feature, this housing version offers a deeper milling in order to optimally protect the foil edge. A deeper recess protects the design foil even better against delamination.

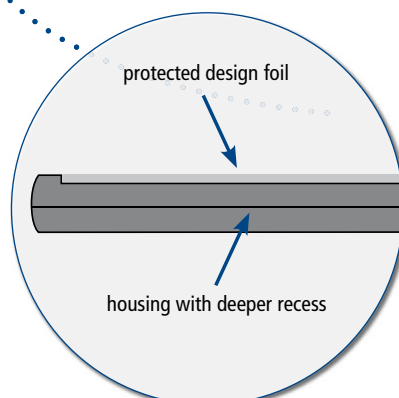

web : www.scanmagnetics.com



TKF-085a-TB38-KGEH



TKF-085a-TOUCH-KGEH

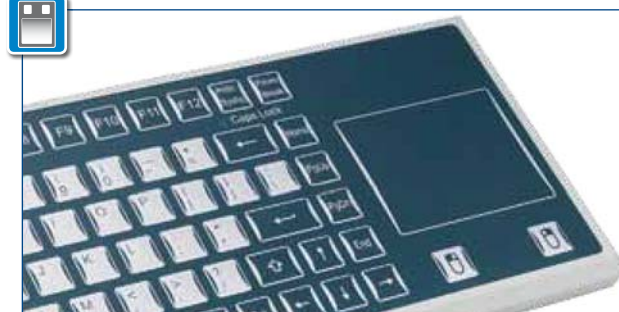

TKF-085c-TOUCH-MGEH

email : indukey [at] scanmagnetics.com



TKF Series – Housing



TKF-085a-OEM

This mounting variant can be integrated into systems by means of adhesive foils on the rear side. The keyboard is flexibly usable, since no mechanical incorporation is required.

Technical data: housing versions

Switching technology: Gold plated domes
 Switching force: 3 N
 Switch travel: 0.6 mm
 Switching cycles: approx. 1 Mio. (per key)
 Material: MGEH version: aluminium, metal housing
 KGEH version: ABS, plastic housing
 Interfaces: PS/2; USB
 Operating temp.: -25 °C to +70 °C¹
 Storage temp.: -25 °C to +80 °C
 Layout (standard): QWERTY (US); QWERTZ (DE)

Product description	Number of keys	Pointing device	Protection level		Dimensions (mm)	Mounting
			static	dynamic		
TKF-085a-OEM	85	-	IP65		245,5 x 107,5 x 10	Adhesive foil

Product description	Number of keys	Pointing device	Protection level		Dimensions (mm)	Housing
			static	dynamic		
TKF-085a-KGEH	85	-	IP65		274 x 138 x 35	Plastic housing
TKF-085a-TB38-KGEH	85	Trackball, 38 mm	IP65	IP54	350 x 139 x 49	Plastic housing
TKF-085a-TOUCH-KGEH	85	Touchpad	IP65		350 x 139 x 35	Plastic housing

Product description	Number of keys	Pointing device	Protection level		Dimensions (mm)	Housing
			static	dynamic		
TKF-085c-MGEH	85	-	IP65		261 x 116 x 15,5	Metal housing
TKF-085c-TOUCH-MGEH	85	Touchpad	IP65		335,5 x 116 x 15,5	Metal housing

Other layouts, configurations and interfaces on request

¹ Keyboards with pointing device: 0 °C to +70 °C



Other industrial keyboards:

- Foil covered industrial keyboards Page 6
- Intrinsically safe industrial keyboards Page 24
- Keyboards and mice for cleaning and disinfection Page 28
- Stainless steel/ carbon keyboards Page 32
- Keyboards with silicone keys Page 36



Flat input keyboard of the TKF-085a-Series in a portable ultrasonic system for the measurement of the blood flow.

With a protection level of IP65, the TKF-085a keyboards are protected against dust and liquids. They are easy to clean and disinfect.

TKF Series - Front & Rack Mounting



TKF-085a/b-MODUL - Front mounting

TKF-085a/b-MODUL is a compact keyboard which is to be mounted. Threaded bolts on the rear side of the front panel allow an easy installation of the keyboard into systems. The metal frame of the "a-version" is an additional protection in case of rugged applications.



TKF-085a/b-FP - 19" cassette mounting

Due to the mounting boreholes, this compact keyboard is suited for the installation into 19" rack systems or switch cabinet systems. RU designated a rack unit (44.45 mm), HP a horizontal pitch (5.08 mm).



Each available with 38-mm trackball or touchpad

Maahantuojaja : Scanmagnetics Oy - Puh. 09-271 2200



Each available with 38-mm trackball or touchpad

web : www.scanmagnetics.com

email : indukey [at] scanmagnetics.com

TKF Series - Front & Rack Mounting

Technical data:

Switching technology: Gold plated domes
 Switching force: 3 N
 Switch travel: 0.6 mm
 Switching cycles: approx. 1 Mio. (per key)
 Mounting type: see explanation on page 22
 Front panel material: a-version: Aluminium, natural, anodised
 b-version: FR4 (Epoxy glass resin)
 Interfaces: PS/2; USB
 Operating temp.: -25 °C to +70 °C¹
 Storage temp.: -25 °C to +80 °C
 Layout (standard): QWERTY (US); QWERTZ (DE)

Side views ²:

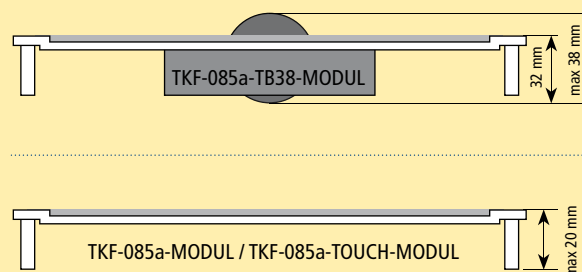

Product description	Number of keys	Pointing device	Protection level		Dimensions (mm)	Mounting
			static	dynamic		
TKF-085a-MODUL	85	-	IP65		274 x 135 x 20	Front
TKF-085a-TB38-MODUL	85	Trackball, 38 mm	IP65	IP54	365 x 135 x 32	Front
TKF-085a-TOUCH-MODUL	85	Touchpad	IP65		365 x 135 x 20	Front
TKF-085b-MODUL	85	-	IP65		274 x 135 x 15	Front
TKF-085b-TB38-MODUL	85	Trackball, 38 mm	IP65	IP54	365 x 135 x 31	Front
TKF-085b-TOUCH-MODUL	85	Touchpad	IP65		365 x 135 x 15	Front

Product description	Number of keys	Pointing device	Protection level		Dimensions (mm)	Mounting
			static	dynamic		
TKF-085a-FP	85	-	IP65		264 x 128,4 x 15	Rack
TKF-085a-TB38-FP	85	Trackball, 38 mm	IP65	IP54	340 x 128,4 x 32	Rack
TKF-085a-TOUCH-FP	85	Touchpad	IP65		340 x 128,4 x 15	Rack
TKF-085b-FP	85	-	IP65		264 x 128,4 x 15	Rack
TKF-085b-TB38-FP	85	Trackball, 38 mm	IP65	IP54	340 x 128,4 x 31	Rack
TKF-085b-TOUCH-FP	85	Touchpad	IP65		340 x 128,4 x 15	Rack

Other layouts, configurations and interfaces on request

¹ Keyboards with pointing device: 0 °C to +70 °C ² Sketched representation



Other industrial keyboards:

- Foil covered industrial keyboards Page 6
- Intrinsically safe industrial keyboards Page 24
- Keyboards and mice for cleaning and disinfection Page 28
- Stainless steel/ carbon keyboards Page 32
- Keyboards with silicone keys Page 36



Foil keyboard of the TKF-085b-Series in robust Ruggedized-PC for the toughest conditions

The Ruggedized-PC is suited for the use in extremely dirty, wet, vibration-exposed or dusty environments, such as e.g. in mining areas or on tunnel boring machines, outdoors on construction machines or harbour facilities, in water works or saw mills, as well as in brickworks.



EX Series

The keyboards of this category are used in areas where a potentially explosive atmosphere occurs. This does not only apply to „classical“ explosion-prone areas such as tank farms or mines, but also increasingly to industrial environments. There are two possibilities to prevent an explosion – either the formation of an explosive atmosphere is prevented or the ignition of which. In most cases it is not possible to eliminate an explosive

atmosphere. Consequently, the ignition of such a mixture must be avoided. This means that all devices, being a potential ignition source when used in explosion-prone areas, must be designed in such a way that an ignition is impossible. The keyboards of this category are completely certified and tested for the following protection zones:



Intrinsically Safe Industrial Keyboards



Mounting/ housing type:



Housing

Page 27



Front mounting

Page 27

Further characteristics:



Explosion protection

Page 27



Protection level according to IP68

Page 27



Protection level according to IP65

Page 27

Protection zone 1: area in which a potentially explosive atmosphere composed of a mixture of air, combustible gases, vapours or mist may occasionally occur during normal operation.

Protection zone 2: area in which a potentially explosive atmosphere composed of a mixture of air, combustible gases, vapours or mist does normally not, or only temporarily, occur during normal operation.

Protection zone 22: area in which a potentially explosive atmosphere consisting of a cloud of combustible dust contained in the air does normally not, or only temporarily, occur during normal operation.

Intrinsically Safe Industrial Keyboards

EX Series

www.ex.indukey.com



Metal housing

This Intrinsically safe keyboard is available as housing variant. Due to the metal front panel and the stainless steel housing, the keyboard is extremely resistant. For this keyboard, a decoupling device for the galvanic isolation between the keyboard and the system is required. This barrier can be ordered as well.



Front mounting

This Intrinsically safe keyboard, being a front panel model, can easily be integrated into systems by means of threaded bolts which are located on the rear side. Here again, a decoupling device for the galvanic isolation between the keyboard and the system is required which can be ordered as well.



Entirely covered silicone keyboard

This intrinsically safe keyboard and the intrinsically safe mouse are completely covered with silicone, which makes them entirely waterproof and dustproof. In order to be able to use the keyboard in explosion-prone areas, a decoupling device becomes necessary in this case as well.



Available as version with 50-mm trackball or touchpad



Available as version with 50-mm trackball or touchpad



Optical silicone mouse: TKH-MAUS-EX-IP68-GREY-OPT

Maahantuoja : Scanmagnetics Oy - Puh. 09-271 2200

web : www.scanmagnetics.com

email : [indukey \[at\] scanmagnetics.com](mailto:indukey[at]scanmagnetics.com)



EX Series

Technical data:

Switching technology: short travel keys
 Switching force: 2.6 N
 3.0 N silicone keyboard
 Switch travel: 0.3 mm
 Switching cycles: approx. 1 Mio. (per key)
 Front panel material: TKS version: aluminium
 TKG version: silicone
 Interfaces: PS/2; USB
 Operating temp.: 0 °C to +50 °C
 Storage temp.: 0 °C to +60 °C
 Layout (standard): QWERTY (US); QWERTZ (DE)

TKA Interface EX:

For this keyboard, a decoupling device for the galvanic isolation between the keyboard and the system is optionally required.



Product description	Number of keys	Pointing device	Protection level		Dimensions (mm)	Housing
			static	dynamic		
TKS-105-EX-MGEH	105	-	IP65		508 x 231 x 52	Metal housing
TKS-105-EX-TB50-MGEH	105	Trackball, 50 mm	IP65	IP54	508 x 231 x 52	Metal housing
TKS-105-EX-TOUCH-MGEH	105	Touchpad	IP65		508 x 231 x 52	Metal housing
TKA-EX-VERSORGUNG-TKS	Please order the EX keyboard interface separately					

Product description	Number of keys	Pointing device	Protection level		Dimensions (mm)	Mounting
			static	dynamic		
TKS-105-EX-MODUL	105	-	IP65		482,6 x 177,8 x 15	Front
TKS-105-EX-TB50-MODUL	105	Trackball, 50 mm	IP65	IP54	482,6 x 177,8 x 54	Front
TKS-105-EX-TOUCH-MODUL	105	Touchpad	IP65		482,6 x 177,8 x 52	Front
TKA-EX-VERSORGUNG-TKS	Please order the EX keyboard interface separately					

Product description	Number of keys	Pointing device	Protection level		Dimensions (mm)	Housing
			static	dynamic		
TKG-105-EX-IP68-GREY	105	-	IP68		387 x 150 x 23	Silicone housing
TKH-MAUS-EX-IP68-GREY-OPT	2	optical silicone mouse	IP68		127 x 63 x 33	Silicone housing
TKA-INTERFACE-EX	Please order the EX keyboard interface separately					

Other layouts, configurations and interfaces on request



Other industrial keyboards:

Foil covered industrial keyboards	Page 6
Flat input keyboards	Page 18
Keyboards and mice for cleaning and disinfection	Page 28
Stainless steel/carbon keyboards	Page 32
Keyboards with silicone keys	Page 36

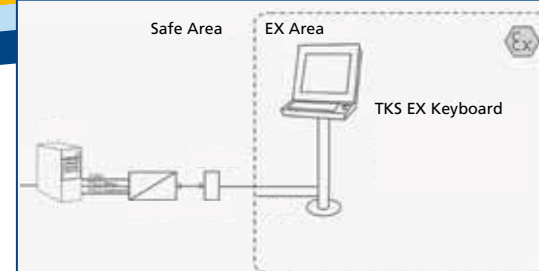

Data input devices as electromechanic devices, being a potential source of ignition, are subject to specific technical modifications and are furthermore confronted with demanding industrial environments. For the operation in explosion-prone areas, the operating devices are at first separated from the system and from the remaining periphery, which are located in a safe area (see picture). For this, a so called barrier is used, which allows for the galvanic isolation of the two circuits. Without this barrier, the proper use of an intrinsically safe data input device is not possible. The distance between the operating element and the barrier can amount to up to 10 m.



InduProof Series

Waterproof, Disinfectable Input Devices

The keyboards and mice of this category are equipped with a closed silicone surface. Thus, they are completely protected against liquids and dust – the protection level is IP68.

These devices are particularly suited for environments which have to meet high hygienic requirements. Especially hospitals, laboratories, companies which are active in the fields of food and pharmaceutical production as well as

manufacturers of microelectronic products benefit from the excellent features of these keyboards and mice. Since the devices are completely disinfectable and cleanable, bacteria and germs can be eliminated. In addition, some models possess antimicrobial properties, which attack microbes that are located on the surface and inhibit their growth. The robust construction ensures a long service life. With some models, in addition to the mouse, a cursor control is available which is integrated into the keyboard.



Keyboards and Mice for Cleaning and Disinfection



Mounting/ housing type:



Housing

Further characteristics:



Protection level IP68



Antimicrobial surface



Underwaterproof



Version with touchpad



Version with mouse button



Version with backlight

The models of the IP68 family are particularly used in the following application areas and industries:

- Medical engineering
- Pharmaceuticals
- Chemical industry
- Food industry
- Clean room applications
- Military



InduProof Series



The models of the new InduProof-generation are designed as desktop versions and are therefore operable on all even surfaces. Additionally, there are VESA boreholes on the rear side (75 mm matrix) which allow for a mounting of the keyboard on accordant fixtures.

ON/OFF switch: The disengagable electronic system allows for a complete cleaning even while the system is running!

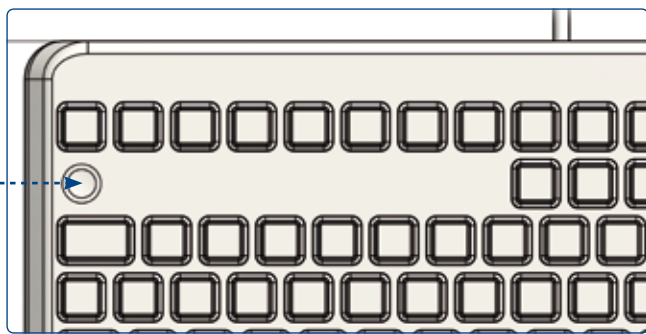

Maahantuojia : Scanmagnetics Oy - Puh. 09-271 2200



The silicone surface of this keyboard and the mice contains an agent which inhibits the growth of germs. Thus, these devices are suited for the use in areas which are sensitive to hygiene. A coating seals the surface and makes it resistant.

The silicone mouse **TKH-MOUSE-MED-IP68** complements the InduProof^{med} keyboard. They contain the same antimicrobial additive. The surface is equally sealed by the coating.

The silicone mouse **TKH-MOUSE-SCROLL-IP68-GREY-OPT** is equipped with a scroll-function.



web : www.scanmagnetics.com



TKG-105-MB-IP68-GREY / BLACK
The keyboard InduProof¹™ is the basic version of the successful InduProof Series. Due to the strongly outlined silicone key caps and the short travel keys beneath those caps, the keyboard can be operated easily. An integrated mouse button provides for the precise cursor control.

TKG-105-IP68-GREY / BLACK
The keyboard InduProof²™ is a silicone-covered keyboard in MFII-layout. Flattened key caps and mechanical short travel keys offer a pleasant tactile feedback.

TKG-086-MB-IP68-GREY / BLACK
The keyboard InduProof³™ is equipped with an integrated mouse button. Also available as version with backlight which is dimmable in eight stages.

email : [indukey \[at\] scanmagnetics.com](mailto:indukey@scanmagnetics.com)



Technical data	InduProof Advanced	InduProof ^{med}	InduProof ¹	InduProof ²	InduProof ³
Switching technology	Carbon contacts	Carbon contacts	Short travel keys	Short travel keys	Gold plated domes
Switching force	2 N	2 N	2.6 N	2.6 N	3 N
Switch travel	1.0 mm	1.0 mm	0.3 mm	0.3 mm	0.6 mm
Switching cycles	approx. 3 Mio. (per key)	approx. 3 Mio. (per key)	approx. 3 Mio. (per key)	approx. 3 Mio. (per key)	approx. 2 Mio. (per key)
Interfaces	PS/2; USB	PS/2; USB	PS/2; USB	PS/2; USB	PS/2; USB
Operating temp.	0°C to +70°C	-20°C to +70°C	0°C to +70°C	-20°C to +70°C	0°C to +70°C
Storage temp.	-25°C to +80°C	-25°C to +80°C	-25°C to +80°C	-25°C to +80°C	-25°C to +80°C
Colour	grey	grey; black	grey; black	grey; black	grey; black

Product description	Number of keys	Protection level Pointing device	static	dynamic	Dimensions (mm)	Housing
TKG-105-MED-IP68 - InduProof ^{med}	105	-		IP68	385 x 160 x 22,5	Housing
TKH-MOUSE-MED-IP68	2	Mouse		IP68	127 x 63 x 33	Housing
TKG-105-MB-IP68 - InduProof ¹	105	Mouse button		IP68	387 x 145 x 26,7	Housing
TKG-086-MB-IP68 - InduProof ³	86	Mouse button		IP68	320 x 145 x 22	Housing
TKG-086-MB-IP68-BACKL - InduProof ³	86	Mouse button		IP68	320 x 145 x 22	Housing
TKG-105-IP68 - InduProof ²	104	-		IP68	387 x 160 x 20	Housing
TKG-104-MB-IP68-GREY - InduProof Advanced	104	Mouse button		IP68	340 x 165 x 18,4	Housing
TKG-104-TOUCH-IP68-GREY - InduProof Advanced	104	Touchpad		IP68	340 x 165 x 16,3	Housing
TKH-MOUSE-SCROLL-IP68-GREY-OPT	3	Mouse		IP68	116 x 62 x 38,6	Housing

Product description

TKG-105-MED-IP68-BUNDLE Set consisting of keyboard (TKG-105-MED-IP68) and mouse (TKH-MOUSE-MED-IP68) in grey or black

Other layouts, configurations and interfaces on request



InduProof Advanced for VESA Mounting

If needed, boreholes on rear side for VESA mounting (75 x 75 mm) can be opened by means of „Push-Out“ from plastic bottom plate.

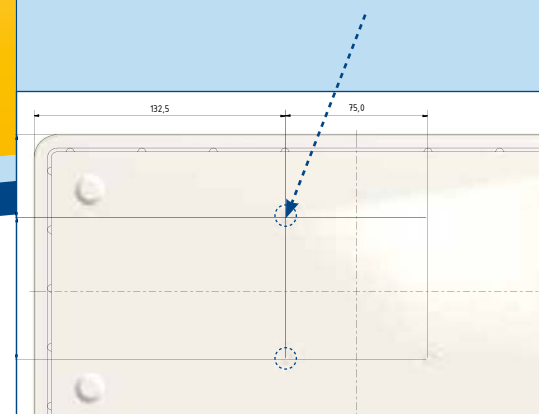

InduMouse: mouse with 3 keys with scroll-function



TKV Series

Metal keyboards are used in areas requiring protection against vandalism and robust features, such as dust formation. This especially applies to places where information terminals or info points are freely accessible to the public. As they are mostly unsupervised and available 24 hours a day, these so-called self-service kiosk systems are exposed to the great danger of mechanical impacts due to vandalism. The advantage of metal keyboards used as data input devices in public space is that they are serviceable for a long period of time. Being equipped with a metal front panel and metal key caps, they do not only resist mechanical impacts occurring

on the surface. As the bottom side of the key caps are provided with a lip, they cannot be levered out.

Moreover, the majority of the models provide an increased IP-Protection level which additionally protects the keyboard against dust and liquids. This way, e.g. beverages which have been spilled over the keyboard, or dirt which reaches the device, cannot damage the electronic system of the keyboard.



Stainless Steel/ Carbon Keyboards



All features and variants
at a glance:



Front mounting



Compact version

or with integrated trackball



or touchpad

Application areas of TKV keyboards:

- Kiosk systems
- Self-service machines
- Service terminals in public spaces
- Points-of-Sale
- Heavy industry

TKV Series – Front Mounting



InduSteel³ with numeric keypad: TKV-105-TB38V-MODUL



InduSteel² with 38-mm trackball: TKV-068-TB38V-MODUL



InduSteel with touchpad: TKV-084-TOUCH-MODUL

 **InduSteel Series**
Robust devices made from stainless steel

InduSteel is a front-mounted keyboard with compact dimensions. Due to the large-scale key labelling, the symbols are well visible. The keyboards of this series are particularly suited for the application in public area, where solely contents for the user guidance are provided, such as information or internet terminals.

With regard to the cursor control, versions with an integrated trackball or touchpad are available. The [TKV-105-TB38V-MODUL](#)-variant is additionally equipped with a numeric keypad.

 **InduDur Series**
Lightweight construction with Carbon

InduDur is the designation for the carbon keyboard series from InduKey. Those in-house developed devices are front-mounted keyboards with a front panel made of carbon; as switch elements, stainless steel keys are used.

Due to the characteristics of the carbonic material, carbon is the ideal material for data input devices: high solidity at a low weight, good processing properties, dimensional stability, and the possibility of the connection with other materials and components.

TKV Series – Front Mounting

Technical data:

Switching technology: carbon contact technology
 Switching force: 1.0 N
 Switch travel: 1.5 mm
 Switching cycles: approx. 10 Mio. (per key)
 Housing type: front panel with threaded bolts
 Front panel material: stainless steel
 carbon (CFK)
 Interfaces: PS/2; USB
 Operating temp.: -25 °C to +70 °C¹
 Storage temp.: -25 °C to +80 °C
 Layout (standard): QWERTY (US); QWERTZ (DE)

Side views ²:

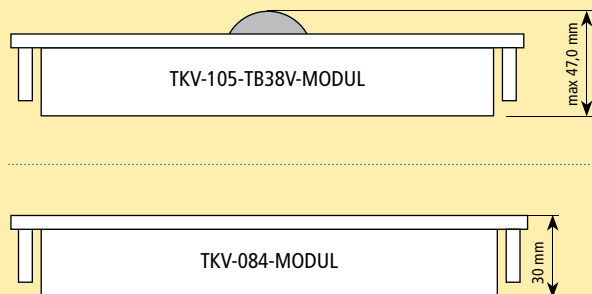

Other industrial keyboards:

- Foil covered industrial keyboards Page 6
- Flat input keyboards Page 18
- Intrinsically safe Page 24
- Industrial Keyboards Page 28
- Keyboards and mice Page 36
- for cleaning and disinfection Page 28
- Keyboards with silicone keys Page 36



Technical data of the integrated touchpad

Operating principle: capacitive
 Resolution: 100-300 dpi
 Dimensions: 65 x 49 mm
 Active surface: 59 x 42 mm

Product description	Number of keys	Pointing device	Protection level		Dimensions (mm)	Mounting
			static	dynamic		
TKV-105-TB38V-MODUL	105	Trackball ³ , 38 mm	IP65	IP54	446 x 145 x 47	Front
TKV-105-TOUCH-MODUL	105	Touchpad	IP65		446 x 145 x 38	Front
TKV-084-MODUL	84	-	IP65		295 x 145 x 30	Front
TKV-084-TB25V-MODUL	84	Trackball ³ , 25 mm	IP65	IP54	370 x 145 x 30	Front
TKV-084-TOUCH-MODUL	84	Touchpad	IP65		385 x 145 x 30	Front
TKV-068-MODUL	68	-	IP65		300 x 125 x 26	Front
TKV-068-TB38V-MODUL	68	Trackball ³ , 38 mm	IP65	IP54	375 x 125 x 45	Front
TKV-068-CFK-MODUL	68	-	IP65		300 x 125 x 25	Front
TKV-068-TB38-CFK-MODUL	68	Trackball, 38 mm	IP65	IP54	375 x 125 x 30	Front
TKV-068-TOUCH-CFK-MODUL	68	Touchpad	IP65		375 x 125 x 27	Front



Other layouts, configurations and interfaces on request

¹ Keyboards with pointing device: 0 °C to +70 °C

² Sketched representation

³ Stainless steel trackball



The InduSteel² keyboards are used in the terminal of the company SOLIDD. With a lean layout of 68 clearly arranged keys, the stainless steel keyboard is oriented on the operation of web-focused applications. The keyboard is protected against damage by means of the metal housing and key caps with lips, which secure the keys against being levered out. The surface of the keys has a trough-shaped design, so that the user experiences a pleasant feeling on the finger tips.



TKG-Serie

Attractive with regard to functionality and design

Those keyboards are equipped with a robust front panel which is combined with a silicone switching mat that is positioned beneath. The keys of the silicone mat are inserted through precisely milled openings in the front panel. The electrical switching impulse is triggered by carbon pills on the bottom side of the silicone keys. When the key is pressed, the pill hits the contact meander of the gold-plated printed circuit board beneath.

The models of this category are available as compact versions or as versions with an integrated trackball or touchpad. In addition, there is the desktop version with a rugged metal housing which is protected against vandalism.



Keyboards with Silicone Keys



All features and variants
at a glance:



Metal housing



Front mounting



Compact version
or with integrated



trackball or touchpad

Keyboards of the TKG series are particularly used in the following industrial sectors:

- Robust operation terminals
- Military engineering
- Control and observation stations
- POS/booth construction
- Digital signage technology
- Indoor conveying systems

Silicone Keyboards TKG Series



Version with metal housing – MGEH

Those keyboards of the TKG Series are equipped with a solid and rugged metal housing. From the silicone keys which have been used here, a soft and almost noiseless keystroke is resulting. The keys are well perceptible for the user and are easy to use.



Version for front panel – MODUL

This front panel version is equipped with threaded bolts on the rear side for the easy installation into systems. Orientation is made easy by the variably coloured keys. The regular keypad is equipped with a numeric keypad-function.



Front mounted panel in silver look – SILVER

This keyboard has been designed as an economically priced alternative to a stainless steel keyboard. Nevertheless, this keyboard is of comparable product quality. With their noble silver look, the models of the SILVER series offer robustness, input comfort and an appealing design.



Available as version with 38-mm trackball or touchpad

Maahantuoja : Scanmagnetics Oy - Puh. 09-271 2200



Available as version with 38-mm trackball or touchpad

web : www.scanmagnetics.com



Available as version with 38-mm trackball or touchpad

email : indukey [at] scanmagnetics.com



Technical data:

Switching technology: carbon contact technology
 Switching force: 1.2 N
 Switch travel: 1.2 mm
 Switching cycles: approx. 3 Mio. (per key)
 Front panel material: aluminium
 Interfaces: PS/2; USB
 Operating temp.: -25 °C to +70 °C ¹
 Storage temp.: -25 °C to +80 °C
 Layout (standard): QWERTY (US); QWERTZ (DE)



Technical data of the integrated touchpad

Operating principle: capacitive
 Resolution: 100-300 dpi
 Dimensions: 65 x 49 mm
 Active surface: 59 x 42 mm

Product description	Number of keys	Pointing device	Protection level		Dimensions (mm)	Housing
			static	dynamic		
TKG-083b-MGEH	83	-	IP65		345 x 165 x 35	Metal housing
TKG-083b-TB38-MGEH	83	Trackball, 38 mm	IP65	IP54	435 x 165 x 56	Metal housing
TKG-083b-TOUCH-MGEH	83	Touchpad	IP65		435 x 165 x 49	Metal housing

Product description	Number of keys	Pointing device	Protection level		Dimensions (mm)	Mounting
			static	dynamic		
TKG-083b-MODUL	83	-	IP65		305 x 134 x 10	Front
TKG-083b-TB38-MODUL	83	Trackball, 38 mm	IP65	IP54	405 x 135 x 45	Front
TKG-083b-TOUCH-MODUL	83	Touchpad	IP65		405 x 135 x 15	Front
TKG-083-MODUL-SILVER	83	-	IP65		305 x 134 x 10	Front
TKG-083-TB38-MODUL-SILVER	83	Trackball, 38 mm	IP65	IP54	405 x 135 x 45	Front
TKG-083-TOUCH-MODUL-SILVER	83	Touchpad	IP65		405 x 135 x 15	Front

Other layouts, configurations and interfaces on request

¹ Keyboards with pointing device: 0 °C to +70 °C



Other industrial keyboards:

Foil covered industrial keyboards	Page 6
Flat input keyboards	Page 18
Intrinsically safe	
Industrial keyboards	Page 24
Keyboards and mice for cleaning and disinfection	Page 28
Keyboards which are protected against vandalism	Page 32



Operating terminal in aerospace exhibition

Used in multi-user-terminals, the keyboard provides access to interactive presentations. In a virtual spaceship, the user can rapidly set his course for the different planets, perform adventurous landing manoeuvres or get information about the celestial bodies he is about to head for.



TKH-Serie

Possibilities of industrial cursor control

The devices of this category are cursor control systems for rugged environments. They include mice, mechanical and optical trackballs, touchpads, mouse buttons and joysticks.

Trackball

The various trackball types can either be directly integrated into the system or they can be used as stand-alone mounting types for the corresponding application.

Which of the two options is selected by the user, depends on the respective operational environment. Our range includes mechanical and optical trackballs which are available as plastic or metal versions. We also offer different variants with regard to the protection level. Cursor control by using a trackball is the most popular alternative to the computer mouse.

Touchpad

In particular for notebook users, touchpads offer a familiar tactile feedback. Basically, the application of touchpads



Pointing Devices



Mounting/ housing type:



Front mounting

Page 23



Rack mounting

Page 23



Trackball



Touchpad



Joystick

allows to achieve the highest degrees of protection, since the complete surface is sealed.

Joystick

A further mounting option is the OEM joystick. The standard version of the joystick features two axes, a cursor stick with integrated mouse button and a compact and robust housing according to the protection level IP65. Due to the extremely precise navigation, the device is ideally suited for the application in medical engineering, automation, as well as in control systems of monitoring cameras.

The product decision depends on the one hand on the technical requirements to be met by the device, and on the other hand on the operating preferences of the user. Furthermore, for all technologies, customized solutions are offered as well.

Pointing Devices TKH Series

www.tkh.indukey.com



TKH-TB38b-MODUL - Front mounting



TKH-TOUCHb-MODUL - Front mounting



TKH-JSTb-MODUL - Front mounting

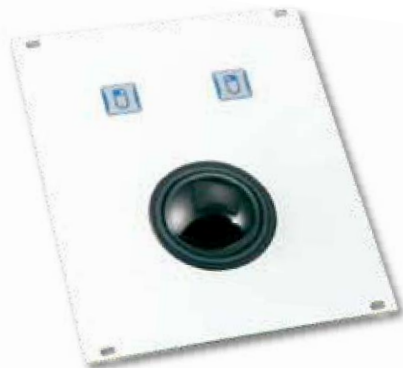

TKH-TB38b-FP - Rack mounting



TKH-TOUCHb-FP - Rack mounting



TKH-TB50-AL-NAT-FP - Rack mounting

Maahantuojaja : Scanmagnetics Oy - Puh. 09-271 2200

web : www.scanmagnetics.com

email : [indukey \[at\] scanmagnetics.com](mailto:indukey[at]scanmagnetics.com)



Pointing Devices TKH Series

Technical data: TKH-TB38/TOUCH/JST

Switching technology: gold plated domes
 Switching force: 3 N
 Switch travel: 0.6 mm
 Switching cycles: approx. 1 Mio. (per key)
 Trackball lifetime: 3 Mio. revolutions
 Mounting type: FP: front panel with mounting
 boreholes for 19" cassette-mounting
 MODUL: front panel with
 threaded bolts
 Front panel material: FR4 (Epoxy glass resin)
 Interfaces: PS/2; USB
 Operating temp.: 0 °C to +70 °C
 Storage temp.: 0 °C to +70 °C

Technical data: TKH-TB50-AL-NAT-FP

Switching technology: carbon contact technology
 Switching force: 1.2 N
 Switch travel: 1.2 mm
 Switching cycles: approx. 3 Mio. (per key)
 Trackball lifetime: 3 Mio. revolutions
 Mounting type: FP: front panel with mounting
 boreholes for 19" cassette-mounting
 Front panel material: Aluminium
 Interfaces: PS/2; USB
 Operating temp.: 0 °C to +70 °C
 Storage temp.: 0 °C to +70 °C

Product description	Number of keys	Pointing device	Protection level		Dimensions (mm)	Mounting
			static	dynamic		
TKH-TB38b-MODUL	2	Trackball, 38 mm	IP65	IP54	135 x 110 x 38	Front
TKH-TB38b-FP	2	Trackball, 38 mm	IP65	IP54	128,4 x 106,4 x 38	Rack
TKH-TB50-AL-NAT-FP	3	Trackball, 50 mm	IP65	IP54	128,4 x 106,3 x 59	Rack

Product description	Number of keys	Pointing device	Protection level		Dimensions (mm)	Mounting
			static	dynamic		
TKH-TOUCHb-MODUL	2	Touchpad		IP65	135 x 110 x 10	Front
TKH-TOUCHb-FP	2	Touchpad		IP65	128 x 106,4 x 10	Rack

Product description	Number of keys	Pointing device	Protection level		Dimensions (mm)	Mounting
			static	dynamic		
TKH-JSTb-MODUL	2	Joystick		IP65	128,4 x 106,4 x 102,8	Front

Other layouts, configurations and interfaces on request



Other input devices and technologies:

Keyboards for standard areas	Page 7
Decoder	Page 47
Accessories	Page 46
Customized solutions	Page 49



Technical data of the integrated touchpad

Operating principle:	capacitive
Resolution:	100-300 dpi
Dimensions:	65 x 49 mm
Active surface:	59 x 42 mm



Precise cursor control under difficult industrial conditions.

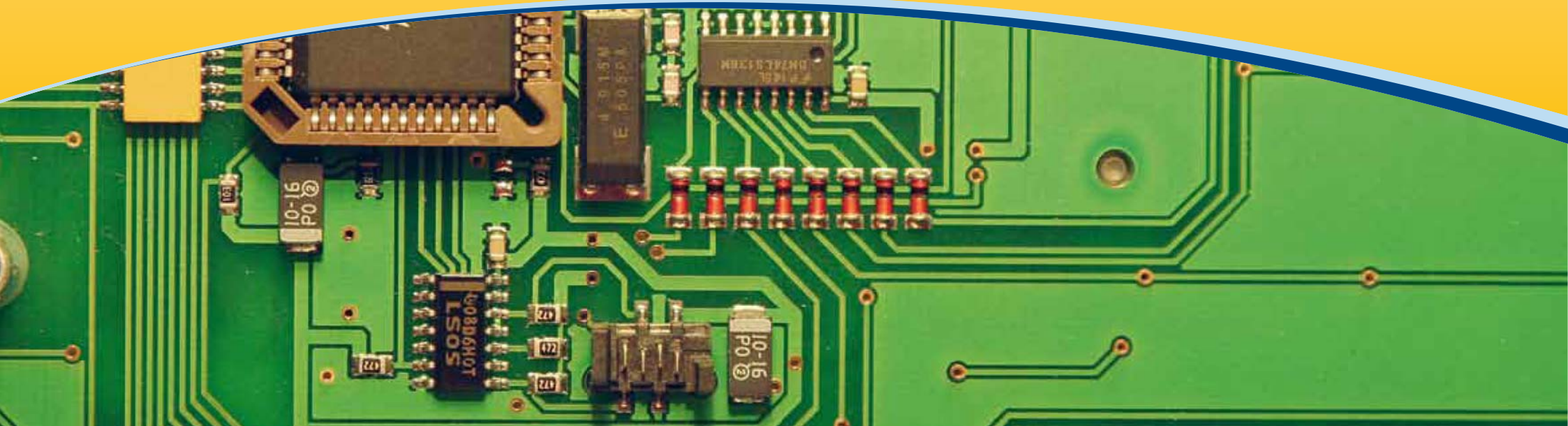

TKC Series

This category includes not only keyboard and trackball controllers, but also terminal controllers for establishing an own control station. Controllers are the electronic interfaces between the key matrix of the keyboard and the PC. The function of these components is to identify the keys being pressed by using a special software.

Internal code tables contain the corresponding country layouts and the interfaces to be activated.

Freely programmable keyboard controllers and decoders allow for an individual configuration of the single keys (multiple functions are possible as well). For this, a software which is easy-to-handle is available.



Decoders & Accessories



Decoders

Page 47

- Keyboard decoder
- Decoder for matrix keyboard
- Serial mini terminal decoder
- Trackball decoder

Accessories

Page 46

- Mounting set for wall/ table mounting
- Electronic track switch



TKA MOUNTING SET

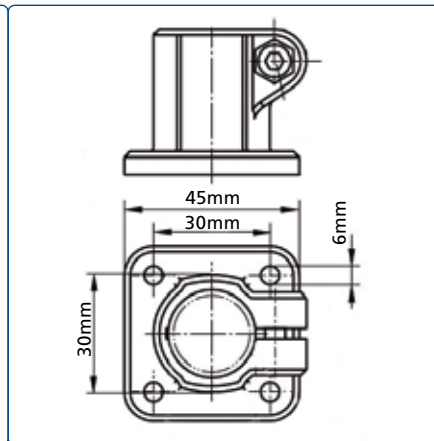
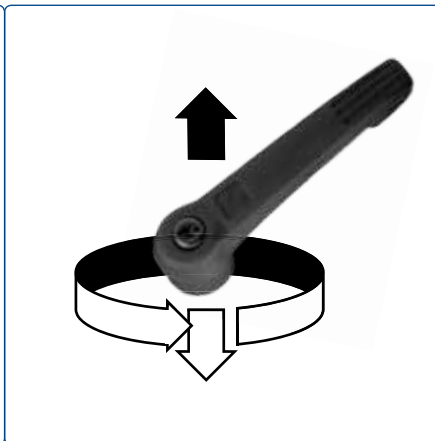
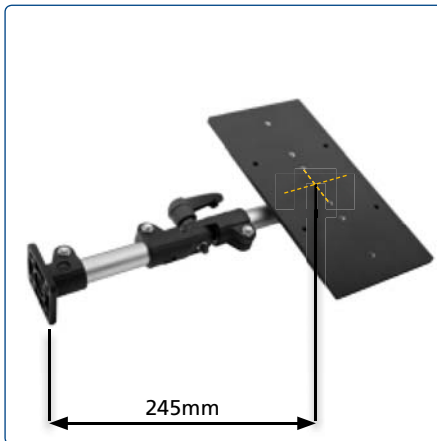
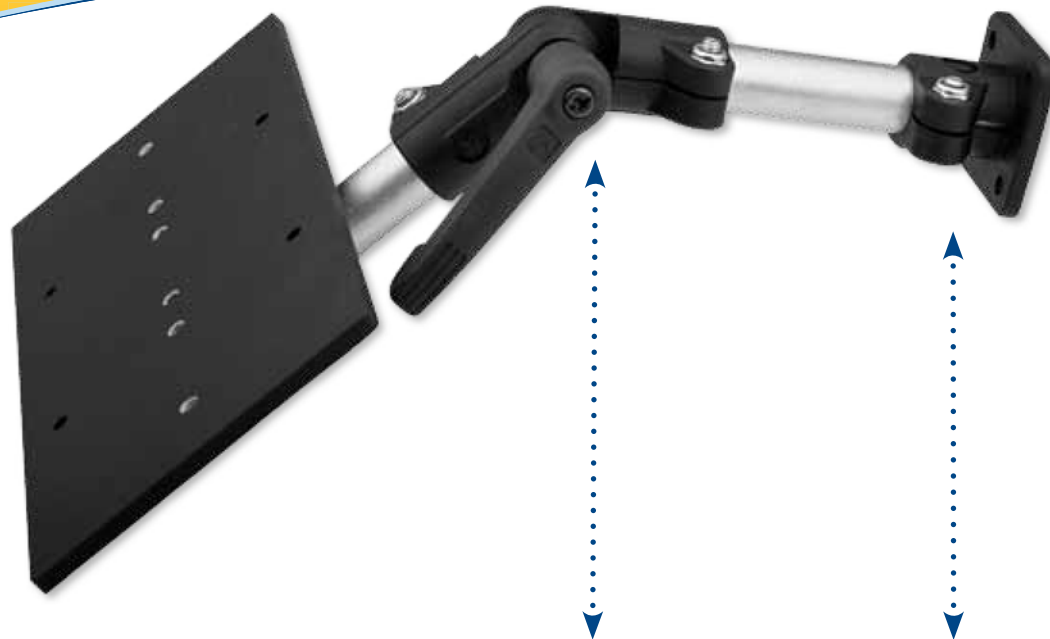

Accessories:

This universal solution is suitable for the flexible wall/ table mounting of keyboards.

- This mounting set is easily adjustable by means of a clamping lever and locking screws
- Steplessly rotatable and inclinable up to 180° in all directions
- Carrier plate with fastening holes according to VESA standard (75 x 75 mm); Aluminium, black, anodised
- Length: 245 mm (distance between wall and centre of carrier plate)
- Maximum load capacity 5 kg (temporary loading up to 10 kg)
- Weight 0.5 kg
- Wall mounting screws not included

Product description

TKA-MONTAGE-SET

Other tube lengths and hole circles on request.

Maahantuojaja : Scanmagnetics Oy - Puh. 09-271 2200

web : www.scanmagnetics.com

email : indukey [at] scanmagnetics.com



i Decoder

Product description	Description	Interfaces	Max. number of keys per level/ number of levels	Plug-in connector key matrix	Plug-in connector interfaces	Operating voltage	Current consumption	Operating temperature	Dimensions
TKC-8000	Freely program- mable decoder	USB; PS/2; AT	128 (16 x 8)/ 2	2 x 16 pole RM 1,27	MICS/SMD4 or Picoflex	5 V DC	ca. 40 mA (without LED)	0°C to 70°C	45 x 25 x 11 mm
TKC-6800	Freely program- mable decoder	USB; PS/2; AT; ADB*	128 (16 x 8)/ 2	2 x 16 pole RM 1,27	MICS/SMD4 or Picoflex	5 V DC	ca. 25 mA (without LED)	0°C to 70°C	98 x 58 x 12 mm
TKC-14000	Hard-wired keyboard decoder	USB; PS/2; AT	142/ 2	2 x 17 pole RM 2,54	MICS/SMD4	5 V DC	10 mA	0°C to 70°C	65 x 50 x 10 mm
TKC-5000	Decoder for matrix keyboard	PS/2; AT	128 (16 x 8)/ 3	2 x 16 pole RM 2,54	MICS/SMD4 or Picoflex	5 V DC	ca. 27 mA (without LED)	0°C to 70°C	98 x 58 x 25 mm
TKC-6100	Serial mini terminal decoder	RS232 / V.24	128 (16 x 8)/ 4	2 x 17 pole RM 2,54	MICS/SMD4	5 V DC (external)	max. 350 mA	0°C to 70°C	111 x 70 x 20 mm
TKC-7500	Trackball decoder	USB; PS/2; RS232	3 (mouse keys)	Solder pads or MICS/SMD4	MICS/SMD4 MICS/SMD6	5 V + 0,25 V DC	12 mA (typ.) 28 mA (max.)	0°C to 55°C	40 x 56,5 x 22 mm

* ADB = Apple

i Accessories

The electronic track switch allows for a simultaneous use of two PS/2 keys on one computer. For this purpose, different plug/ socket combinations are available on request.



Electronic track switch: TKH-3-ELEKTR

Product description	Description	Inputs	Dimensions (mm)	Cable length
TKH-3-ELEKTR	Electronic track switch for keyboard	2 x 6 pole MiniDIN socket	70 x 36 x 30	90 cm

Circuits with priority version available on request



Technologies

The general trend towards the differentiation of technical systems calls for the differentiation of the necessary components as well. Correspondingly, systems which are manufactured in small and medium quantities according to the exact specifications of the customer require individual data input devices.

Data input systems and components are particularly subject to this dynamics. The starting-points of design and development refer to the following applicational

perspectives: shape, switching technology, functionality and design. By means of a combination of those criteria, which are uncompromisingly oriented on the respective applicational case or case of need, the customer gets the best possible data input solution. This process starts with the idea, continues with the conceptualisation, development and manufacture and finally leads to the commissioning of the device. A technically mature, barely reproducible (because unique) product is the ideal result of a customer-specific system.



Customized Solutions



Short Travel Keyboards	Page 50
Flat Input Keyboards	Page 51
Flexible Membrane Keyboards	Page 52
Design Foils and Front Panels	Page 53
Silicone Keypads	Page 54
Long Travel Keyboards	Page 55
Stainless Steel / Carbon Keyboards	Page 56
Touchscreens	Page 57
Enclosures and Devices	Page 58
Lighting	Page 59

The InduKey business division „Customer-Specific Data Input Devices“ is sufficiently experienced due to hundreds of successful „Made-to-Measure“-projects in various field of application. The drivers of success of this strategic business division are the technical know-how, a strict orientation on the customer’s needs, and a solutions philosophy that is lived.



Short Travel Keyboards

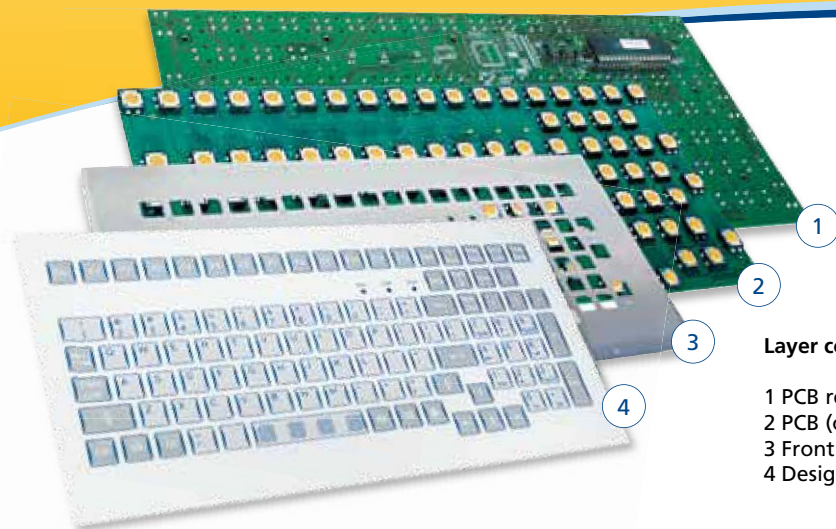

Layer construction of a short travel keyboard

- 1 PCB rear side (here with integrated key controller)
- 2 PCB (component side for keys)
- 3 Front panel (carrier plate)
- 4 Design foil

The technology at a glance

This technology uses high-quality short travel keys which are located behind a front panel made of metal. The front panel screens the device from electromagnetic interferences and gives the component assembly an increased inherent rigidity. The front panel is covered with a protective and design-oriented printed polyester foil. This foil protects the keyboard against dirt and humidity. The short travel keys provide the user with a clear tactile feedback.

Short travel keys have a very long service life. They are available in multiple sizes and with various actuating forces. The actuation travel amounts to approx. 0.3 mm. Short travel keyboards are manufacturable in all possible mounting and housing variants.

Important technological advantages

- Protective and stabilizing front panel
- Dirt and water resistant
- Excellent tactile feedback
- Different key sizes and operation forces
- Point lighting or complete lighting of the keys
- Integration of display windows is possible
- Shapely front foils with a pleasant design
- Good key separation realizable by rim/ key embossing or relief foil
- Manufacture according to your specifications
- Layout and colour design according to your wishes
- The use of an antimicrobial keyboard foil is possible



Preferred application areas

- Special machine engineering
- Medical high-end devices with redundancy functions
- Indoor and outdoor information terminals
- Tool building for measuring and control technology
- Safety control systems of all kinds
- Industrial applications





Flat Input Keyboards

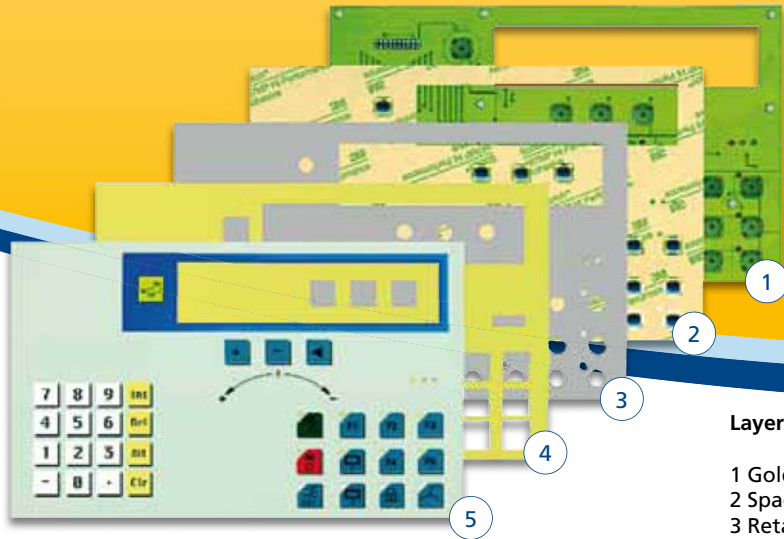

Layer construction of a flat input keyboard

- 1 Gold-plated PCB with integrated switching elements
- 2 Spacer foil
- 3 Retaining/ protective foil
- 4 Adhesive foil
- 5 Design foil

The technology at a glance

These components have a flat design. The lower, switch actuating element in this case is a solid printed circuit board (PCB). This ensures a high inherent rigidity. The key positions are equipped with gold-plated contact points. These „gold on gold contacts“ offer very high switch reliability. The metal domes are placed in the openings of the spacer foil and fixed with a retaining foil. The top layer of the keyboard is a printed design foil available in many colours. On the back of the PCB, complete component assemblies, such as keyboard controllers, can be integrated using SMD technology.

Flat input keyboards are manufacturable in all possible mounting and housing variants.

Important technological advantages

- Individual layouts and colours
- Minimum space required due to compact design
- Key legends can be changed (exchangeable text)
- Ideal pressure point due to metal domes
- Good tactile feel of the key positions due to embossing
- Rear side integration of electronic components (e.g. keyboard controller) possible
- Polyester front foil featuring a high chemical resistance
- Dirt and splash water proof
- No risk of silver migration
- The use of an antimicrobial keyboard foil is possible on request



Application fields

- Machine engineering and system controls with small mounting depth
- Ideal for medical devices
- Measuring and control technology
- Space-saving keyboards for industrial PCs
- System control elements, e.g. for heating systems or industrial panels

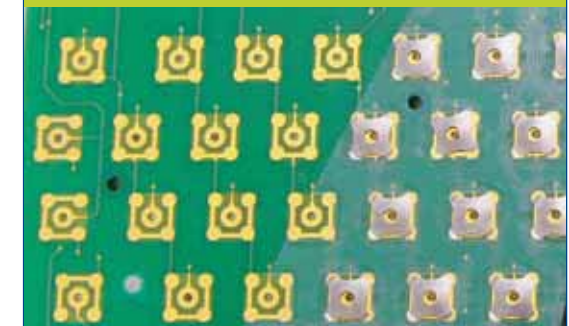



Flexible Membrane Keyboards

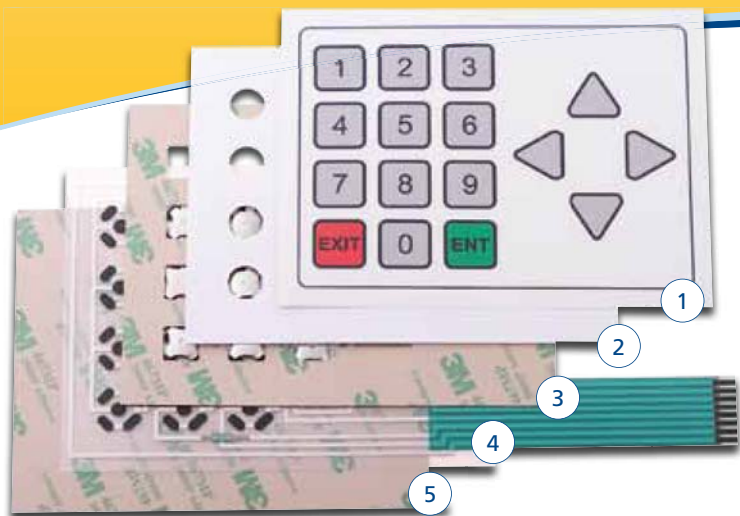

Layer construction of a flexible membrane keyboard

- 1 PCB track foil with integrated switching elements (switching foil)
- 2 Spacer foil
- 3 Retaining/ protective foil (optional)
- 4 Adhesive foil for design foil
- 5 Design foil

The technology at a glance

Membrane keyboards consist of several foil layers which are bonded with each other. Polyester foils printed with conductive silver paste are used as switch membranes. The top and bottom switch membranes are spaced from each other by means of a spacer foil. The contact closes when the upper design foil is pressed in the area where the key is located. The design foil is placed on the upper switch membrane. This design foil is highly transparent and has a fine-textured or smooth surface. This foil can be printed with various colours and inforatory contents. As the keys are separated by means of rim, dome or key embossing, they provide a good tactile feedback and finger guiding.

Important technological advantages

- Easy to clean with customary cleaning agents
- Flat design suitable for industrial applications
- Resistant against dust and humidity
- Customized controllers available
- Individual layouts and colour schemes
- Terminal lugs for zero insertion force connectors or crimped connectors
- Polyester foil is resistant against many chemicals
- Excellent tactile feel due to embossing
- Metal domes can be integrated
- Good key separation due to rim, dome or surface embossing



Application fields

- Consumer products of any kind
- Mass products in all industries
- Computer games and electronic toys
- Electronic balances and home devices
- Mobile data collection terminals
- Medical and analysis equipment



Design Foils & Front Panels



Design foils

Mostly, the foils are based on special transparent polyester. They feature a very high transparency and a fine-textured surface. In order to protect the colours against environmental influences, it is the rear side of the foils which is printed. By special adhesives and spacers, the connection to the lower foil layers and carrier plates is ensured. As a spacer is mounted between the foil and the carrier plate, exchangeable label strips can be inserted. Design foils provided with rim or key embossing ensure an optimum user friendliness.

Front panels

The aluminium, carbon and plexiglas front panels are equipped with all necessary recesses and contour gradients by means of our modern CNC-3D drilling, milling and engraving systems. Large series are blanked at a favourable price. Completed by threaded bolts or other mechanical elements, precise mechanical component assemblies are the result.

Important technological advantages

- Individual layout and colour designs as well as text prints on the foils
- Clearly arranged and multi-coloured prints
- Different embossings improve the tactile feel
- Comprehensive design counselling
- Available either as design foil with adhesive foil on the back side or as foil laminated onto the front panel or the housing
- Front panels separately available, without design foil



Application fields

- All kinds of foil covered keyboards and keyboard covers
- Control panels and console covers
- Appliance rating plates and flow charts
- Separate front panels for your devices
- Vendor parts as semi-finished products
- Control panels laminated with foil





Silicone Keypads



Construction

- 1 Carbon contacts
- 2 Stiffening clip
- 3 Silicone mat

Tools for silicone keypads

The tools for producing silicone keypads are made of a special alloy. They are manufactured with highly precise CNC milling and eroding machines. During one production cycle several silicone keypads can be manufactured simultaneously by using one mould. Thus, already during the manufacture of the tools, the focus is placed on the optimization of the production.

Important technological advantages

- Good tactile feel of the single keys
- An intelligent contact design ensures safe contact making on the PCB
- Silicone can be provided with a coating
- Optionally available with plastic caps
- Suitable, customized housing available
- Unlimited design options
- Several colour combinations in one keyboard
- Designs with light function available
- Good chemical resistance
- Dirt and water proof
- Very well-priced keyboard in series production

The technology at a glance

Compared to other keyboard technologies silicone keypads offer price advantages particularly in mass production. They are durable and reliable, and almost unlimited design options are possible. The colour and shape of the key caps can be defined freely. Silicone keypads are made of highly elastic and toxin free silicone rubber. The keypads are produced by shaping kneadable base materials at a defined temperature and pressure. Each pad type requires a special tool. In most cases, there is one conductive carbon pill per key on the bottom side. Usually, the lower contact part is based on meander-shaped conductor tracks on foil or PCB.



Application fields

- Medical applications (antimicrobial design / fluorine-silicone)
- Remote controls for TV sets and control systems
- Measuring instruments (e.g. oscilloscopes)
- Phone pads in mobile and standard phones
- Communication systems of all kinds
- Information terminals





Long Travel Keyboards



Important technological advantages

- Anti-glare surfaces
- Different key printing technologies
- High abrasion resistance of the key legends (protective lacquer)
- Customized housing
- Keys based on Gold Cross point technology

The technology at a glance

For data input devices in office environments or for mass data input, customized long travel keyboards with long travel technology are suitable. The individual electromechanical keys are equipped with separate key caps. Typically, the key travel is 2.5 to 4 mm. Those long travel keyboards are available as modular assemblies without housing or as models integrated in special customized housing. The key layout, the colours and key cap printings are made according to customer specifications and after consultation. Due to the use of high-quality key modules, the highest possible reliability of 50 million operation cycles is guaranteed.

Lettering of long travel keys

Depending on the required quantity and the desired combination of the key cap base colour and the colour of the lettering five different lettering technologies are available:

- Engraving
- Pad printing
- Sublimation print
- Two-colour injection moulding
- Laser marking



Application examples

- Special keyboards for POS systems
- Medical devices
- Machine control systems in safe environments
- Manufacture of measuring instruments
- Data processing devices for mass data collection
- Operating data collection





Stainless Steel/ Carbon Keyboards

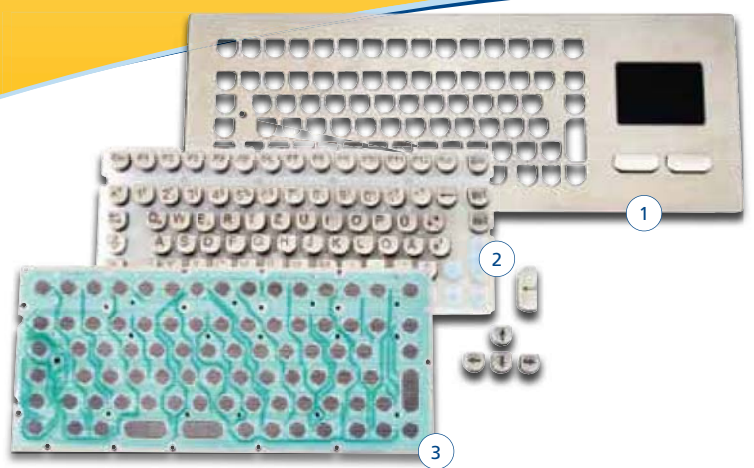

1 Front panel (stainless steel or carbon)
 2 Silicone keypad with stainless steel key caps
 3 Switch membrane with contact meanders

Industrial operating systems - Flexibly configurable component carriers

Control panels can be divided into four basic elements: base carrier or carrier plate/ casing, central data input unit, additional data input unit and data output unit. With these four elements, various versions can be developed which are always oriented towards the demands made by the operational environment.

As component carriers, various materials can be used. In the majority of cases, aluminium is used. Further possible options are carbon or plastic. The carriers can be integrated into the system in various ways. By default, stay bolts for the front mounting of the carrier plate which are mounted on the reverse are used.



Application examples

- Keyboards for Points of Information in public areas
- Ideally suited for internet terminals
- Bancomats and cashpoints
- Ticket machines
- Applications in public area
- Elevator and lift control systems

The technology at a glance

In the age of the Internet, the demand for robust Internet terminals has caused a sudden upvaluation of metal keyboards. However, those input systems are frequently used for the classical applications as well, such as for cash or ticket machines. Those metal keyboards are available as modular component assemblies without housing or as models integrated into special customized housing. The key layout, the external dimensions and the lasing of the key caps are made according to the customer's specifications. Optionally available: a classical, flat key top design or higher key tops ensuring a longer key travel and a higher input speed.

Important technological advantages

- Robust design
- High quality and noble appearance
- Suitable for unsupervised use (outdoors as well)
- Optionally with integrated heating for the use at temperatures below 0°C
- Safe and pleasant tactile feel
- Single keys available
- Integration of electronics (e.g. keyboard controller)
- Lettering is selectable on request
- Backlight function available
- Key positions and external dimensions are freely selectable





Touchscreens



Intuitive operation - Capacitive

In case of digital touchscreens, thin isolating channels are created in the ITO layers in order to produce conductive tapes. As the tapes of the upper and lower ITO films are positioned at an angle of 90° to each other, a key matrix is created. In case of the analogue principle, the ITO layers are not cut. Contact to the upper layer is applied vertically and laterally on both sides – to the lower layer horizontally. The short-circuit point of the two layers is determined by the voltage divider using a complex evaluation electronics.

The technology at a glance - Resistive

A customized touchscreen requires two layers of an ITO sputtered base material, which are separated from each other by means of spacers. ITO stands for indium tin oxide, which is an almost transparent, but conductive material. Sputtering refers to a special method for depositing thin films. Suitable base materials for ITO films are foil or glass.

When pressing the top layer, a conductive connection between the upper and lower ITO layers is established at the pressed point. The position of the contact point is identified by an analytical circuit.

Important technological advantages

- Flat design; no parallax errors
- Can be operated with any kind of soft object, e.g. finger, pencil tip
- No drift and thus no calibration required
- Surface soiling does not affect functioning
- Analogue or digital principle available
- Main dimensions can be freely selected
- Terminal lug is based on copper conductor tracks
- Through-connection on the terminal lug is possible – all connections on one side
- High light transmission
- Scratch-proof surface coating



Application examples

- Computer technology: note pads, information terminals
- Multimedia: information systems, POS consoles and internet terminals
- Medical engineering: patient monitoring systems
- Industry: process monitoring, control panels, process visualization systems
- Toys industry: interactive games





Enclosures and Devices



Enclosures and Devices

Besides the keyboard unit, a suitable housing is an essential component of an operating system. Very often, the standard housing range does not satisfy customer needs. Therefore, InduKey develops and provides customized keyboard or device housing. For this, we use the different manufacturing technologies of our suppliers being selected in such a way that they are optimally suited for your application with regard to design and manufacturing costs. Whether plastic or metal, we will provide you with the adequate housing.

Metal housing

- Use of standard extruded profiles
- Design of bowl casings
- Highly robust and protective
- IP level up to 65 available
- Different surface coatings

Negative deep drawing

- Suited for series production of medium quantities (< 500 pieces)
- Cost-efficient manufacture of the deep-drawing die
- Design-oriented undercuts available
- Various joint designs available
- Different surface textures

Tool-free housing technology

- Suited for prototypes and medium series
- Plate material is scored and bent
- Front panels are specifically glued
- For simple geometric contours
- No tool making required

Injection moulding

- Suited for large-scale production
- Cost-efficient serial production of housing
- Dimensional stability
- Complicated spherical contours possible
- Cost-efficient tool making and manufacture



Housing made by:

- Sand and dead-mould casting or pressure die and waste wax casting
- Aluminium pressure die casting
- Magnesium pressure die casting
- Magnesium waste wax casting
- Plastic injection moulding

... we find the optimum technology for your robust housing.

Lighting of Operating Surfaces

LED keys

With this method, the according lighting element is directly integrated into the key. In most cases, the lighting elements are LED's which have a service life of approx. 50,000 hours. Those LED's are available in various colours. Due to the transparency of the surface material of industrial keyboards, the keys can be illuminated effectively. As surface material, both foil and silicone can be backlitged due to their partial transparency. As illuminated keys, both short travel and long travel keys can be used.

The advantage of this method is that no setup costs are arising, since the keys can be assembled onto the board in the conventional way and without additional efforts.

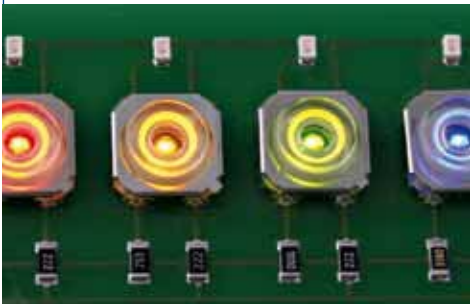

Free LED

In case of this technology, the LED's are not constructionally linked to the key. They are either placed beneath or below the key, or they are position-independently placed as signal indicators (e.g. caps lock key). The latter function is the one which is more frequently used with regard to this technology. For the most part, here, On/Off-modes are visually realized. „Standalone-LED's" also can be used to indirectly illuminate keys without having to integrate them into the respective key. In case of silicone keyboards without mechanical switching elements, for example, the LED's are positioned directly below the key. By using this method, also plated domes can be illuminated without having to integrate the LED's constructionally. Here, the LED is fixed below the key.



EL foils

This interesting lighting method is based on the effect that energy is transformed into light when AC voltage is applied (electroluminescence). This way, the entire „EL foil", which is located below the actual operating/decor foil, can be illuminated. All cut-outs on the foil are not illuminated. This allows for the manufacture of almost layout-independent lightings for operating surfaces. Here, compared to the usage of LED's, non-recurring costs are arising due to the individual adjustment. However, the half life of the luminance is not as high as with the other technologies. After 10,000 hours, the luminance amounts to circa 50% of the original value.



Plastic light ducts

At first, in this case as well, an LED is used as light source. In contrast to other technologies, though, the light is emitted into light ducts made from plastic. Those light ducts have been abraded by means of chemical processes, so that the light is emitted there.

This so called fiberlight-method is very versatile; due to the light scattering and the individual length of the light ducts, operating surfaces of all sizes are backlightable. Due to the respective specific odification, setup-costs are arising when this method is applied.



IP protection classes



The protection class with the two-digit IP codes (1st digit, 2nd digit) indicates the suitability of systems for different environmental conditions. According to DIN the abbreviation IP stands for International Protection.

1st digit	Protection against contact	Protection against foreign objects
0	- no protection	- no protection
1	- with large-area body parts (back of the hand)	- large foreign objects, ø bigger than 50 mm
2	- with the fingers	- mid-size foreign objects, ø bigger than 12 mm
3	- with tools and wires, ø bigger than 2.5 mm	- small foreign objects, ø bigger than 2.5 mm
4	- with tools and wires, ø bigger than 1.0 mm	- granular foreign objects, ø bigger than 1 mm
5	- complete protection	- dust deposit
6	- complete protection	- dust entry

2nd digit	Protection against water
0	- no protection
1	- vertically falling dripping water
2	- diagonally falling dripping water
3	- diagonally falling dripping water up to 15° relative to vertical line
4	- spray water up to 60° relative to vertical line
5	- splash water from all sides
6	- jet water
7	- strong jet water
8	- temporary immersion



„Underwaterproof“ is an in-company test standard by InduKey. This standard exceeds the protection level IP68, which until now has been the highest standard for keyboards. Protection level IP68 means that the products are tested for water tightness by temporarily immersing them into water. The devices which are labelled “underwaterproof”, however, have been tested under water for at least 24 hours. In the process, the water column amounts to at least one meter.

Another difference arises during the active testing of the device. In contrast to IP68, where the devices are only passively immersed into water, the testing according to the “underwaterproof” standard involves an active operation of the keys in particular time intervals. In addition, upon completion of this test, a final and comprehensive testing of the keyboards is conducted.

Products which comply with the „underwaterproof“ standard guarantee the user a high resistivity in wet to humid environments and demonstrate durable, robust quality and functionality.

Test parameters

Position of the keyboard:	Common operating position
Water level:	At least 100 cm above the highest point of the keyboard
Water quality:	Tap water
Water temp.:	Room temperature = 295 K +/- 5 K
Test duration:	At least 24 hours
Operating condition:	No operation of the keyboard
Actuation:	During the test: 6-fold actuation of at least 10 keys in intervals of 1 hour in each case
Connection cable:	Non-insulated sockets of the connection cable which are facing away from the keyboard are not immersed into water
Functionality test:	Upon completion of the test, the keyboard has to be fully functional
Visual inspection:	Upon completion of the test, no changes on the keyboard may be detectable

Key Technology & Mounting Types



Short travel keys

Mechanical switch elements used in industrial keyboards with a key travel of 0.3 mm and an actuation force of 3 N. These rugged keys are rated for up to 3 million operations per key. Short travel keys are used in all models of the TKS series as well as in special models of other series.



Gold plated domes

Mechanical switch elements that – as slightly curved metal domes – make contact with the PCB when being actuated. The advantage of the metal domes is their low height. This allows for a very flat keyboard design. The keyboards can be installed in extremely flat panels.



Flexible membrane keys

Flexible membrane keyboards are equipped with polyester foils printed with conductive silver paste. The upper and lower switch membranes are separated by means of spacer foil. A palpable key separation due to rim or key embossing ensures a good tactile feedback.



Metal keys

Metal keys which are primarily used for the TKV series are actually silicone keys. The difference is that silicone keys are provided with metal key caps which cannot be levered out. This is ensured by a brim on the bottom side of the cap, which anchors the cap firmly to the front panel.



Silicone keys

Silicone keys have carbon pills on the bottom side that make contact with the PCB after being actuated. The keys provide a pleasant tactile feedback and a very low noise level. Silicone keys are available in different shapes, colours and with different actuation forces and key travels. In large quantities they are very cost-efficient.



Long travel keys

They are used as mechanical switch elements in conventional PC keyboards. Long travel keys have a key travel of more than 3 mm. They require an actuation force of only 0.6 N. These keyboards are suited for the input of large amounts of data.

Housing version

Desktop versions can be used as so-called standalone versions. They are suited for places where a stable and even surface is available. Due to the plastic knobs on the bottom side of the device, they are skid-proof. One of the advantages of desktop versions is their application flexibility. They can be connected to systems with standard interfaces (PS/2, USB) without any problems.



Front mounted version

The most frequently used integration method for keyboards and cursor controls is the so-called MODUL variant. The studs on the rear side allow a comfortable installation into almost every system of any type. Due to the seals (included in delivery) lying underneath, a high IP protection level is guaranteed.



Rack mounted version (front panel)

Front panel versions are mainly used for integrating data input devices into 19-inch racks or 19-inch drawers. The mounting holes on the sides of the front panel allow a comfortable installation of the device. The keyboards are standardized according to the RU (Rack units; 1 RU = 44.45 mm) of the 19" system (1" = 25.4 mm).



Drawer version

In the product line of foil covered industrial keyboards, so-called keyboard/drawer systems are available. Due to their compact size they are suited for the application in 19-inch mounting systems. The low mounting height of 1 RU (1 RU = 44.45 mm) requires only little space. The extracted drawer has an angle of about 15 degrees allowing for comfortable operation in standing position.



VESA version

The mounting of electronic devices to the wall, the ceiling or to panels is subject to the so-called VESA standard. The back side of the device is equipped with four insert nuts for installing the bolts. The distance between the mounting holes corresponds to a standardized matrix (usually 75 x 75 mm). This mounting method includes the assembly and system integration of desktop devices.





Manufacturing services

From the idea to the delivery, all manufacturing stages are maintained at our company. The processes are particularly tailored to electrotechnical/electromechanical systems and HMI-components/devices.

On request, however, also products for other areas and applications can be manufactured. Due to a reliable and responsive configuration of all involved factors, we are able to manufacture the most diverse and complex systems even in small and medium sized quantities.

Mounting

In the mounting area, the subproducts are joined together in order to manufacture the finished product. By means of the in-company milling shop, cutting plotter department, screen printing, and assembly, the delivery routes are very short; this way, a quick and uncomplicated order processing can be ensured.

In the mounting department itself, we are working in a highly flexible manner by applying the multiple-shift system. Thanks to an experienced and qualified team, we are able to react to orders on short notice in a quick and reliable manner.

Quality management system

The quality management system used by InduKey meets the DIN EN ISO 9001:2008 standards. Clearly structured and organized inspection processes ensure a continuing high quality of our products. These established processes are also applied at outsourced production locations.

ISO certification

In 2010, the recertification according to DIN EN ISO 9001:2008 was successfully achieved. In addition, further certification processes such as internal audits or system audits by major customers take place.

OEM product assembly for all areas in large quantities

Guangzhou InduKey® Assembly Ltd. in Guangzhou, China, offers many years of experience from counselling, OEM manufacture and logistics to transportation.

- Products for the computer periphery
- Electronic gift articles and promotional items
- Sports and leisure time electronics
- Consumer electronics

Technical Know-How

- Support by our experienced development engineers
- Fastest manufacture of approved prototypes
- Many years of experience with regard to OEM manufacture

Assembly Manufacture of large-scale and small series

Basic information on scope of supply:

- Assembly size PCB's
Min. 50 mm x 50 mm
Max. 580 mm x 400 mm
- Max. throughput width reflow oven 500 mm
- Max. print area Ekra E4 355 mm x 355 mm
- Max. wave soldering width 330 mm

Application of the following machines:

- ATF 23 – wave soldering work on through-hole-components
- MIMOT Advantage – placement machine
- EKRA E4 – fully automatic inline printer for screen printing of the PCB's with soldering paste

CNC milling machines, screen printing & cutting plotters

Special coating methods in screen printing

- InduSense® method
- Printing on the back side for maximum abrasion resistance
- Individual layout/colour design and lettering of foils with text
- Comprehensive design consultation

CNC milling machines in the CAD-3D machining centre:

- On the basis of DIN ISO 2768 / DIN 7168
- Pneumatic press for the processing of all PEM force fitting connections from M2 to M8 thread
- Sandblast cabinet

Cutting plotters and further finishing stages:

- Cutting of decor foils, laminating of decors, key embossings on decor foils



Contact & Support



Worldwide Partnership

From its German location, InduKey® maintains a large network of distribution partners. The company has partners on all continents.

In cooperation with the partners, InduKey® ensures that InduKey products and services are globally available. On our homepage (link above) you will find an up-to-date list of our international offices. Please feel free to contact the respective consultants – they will contact you soon and without obligation.

Service and Support

We support you in many ways. On the one hand our sales and consulting team will help you to find the adequate data input solution for your application. On the other hand we provide you with comprehensive support during the commissioning of a product.

You also have the possibility of contacting the manufacturer directly. Thus, time-consuming communication via third parties is avoided. This is an efficient solution for both parties.



Delivery dates

We are making great efforts to deliver you all offered standard products ex stock as fast as possible. If an article cannot be shipped immediately, you will be informed in a timely manner.

Complaints

In case of complaints, please call the number of our technical support department or send an e-mail to support@indukey.com.

Copyright

All contents in this catalogue are subject to copyright. Any use of these contents requires the previous written approval of InduKey. Catalogue number: KW17101.



Professional Data Input Systems Made in Germany

InduKey® Keyboard Production GmbH & Co.
Scanmagnetics Oy
PL 34
00811 Helsinki

Puhelin: 09-271 2200
Fax: 09-271 2210

E-Mail: indukey@scanmagnetics.com
Internet: www.scanmagnetics.com

